

Appendix 2  
Sons of the Law of One



## Sons of the Law of One

The set of several hundred Past Life Readings given by the Sleeping Prophet Edgar Cayce constitute *the most accurate and detailed source of information* concerning the height of the Atlantean civilization, during the spiritually and technologically advanced psychoacoustic era of the pyramid-builders' global infrasonic network. This profound resource presents fascinating scientific data that deserves attention.

Hundreds of psychic readings given over a span of three decades weave an intricate tapestry, retrieving the historical details of a sophisticated matriarchal society that once occupied the Orion pyramids of present-day Giza, Egypt. *This large soul group coalesced around the mandala principle of One Divine Force, as similarly expressed in contemporary scientific understandings of the Unified Field: [  $z_{n+1} = z_n^2$  ].*



The exceptional trance medium Edgar Cayce concisely restated this profound universal concept of the unity of the cosmos in many Life Readings, given during the period from 1920 until his death in 1945:

None is convinced in that science or religious convictions are one. The first lesson for *six months* should be *One – One – One – One*; Oneness of God, oneness of man's relation, oneness of force, oneness of time, oneness of purpose, *Oneness* in every effort – Oneness – Oneness! (Reading 900-429):

The stones... were of the magnetized influence upon which the Spirit of the One spoke to those peoples as they gathered in their service, are of the earliest Atlantean activities in religious service... (Reading 5750-1)

Even in this period... there was the exchange of ideas with other lands, as Poseidia and Og, as well as the Pyrenees and Sicily, and those countries that are now known as Norway, China, India, Peru, and America. These were not their names at that time, but were the portions of the Earth from whence many of the recreations were gathered for the people. The understandings were of one tongue! There had not been the division in tongues, except in the Atlantean or Poseidian land. (Reading 294-153)

Thereby referred to as the Sons of the Law of One, *this group oversaw a long period of technologically elevated social development that has no equal in the history of our planet.* Advanced bioelectrical healing techniques were also described in the Atlantean readings, only to be misunderstood for so many decades. *The unfolding revelations of the Information Age offer a full restoration of knowledge.*

The modern scientific fields of biophotonics and phonon resonance have resolved the quantum trapping dynamics employed in the bioelectrical qi healing arts, whereby advanced yogic practices involving meditation and isometric exercises in underground temple chambers enabled the charging and discharging of bioelectrical forces from the bodies of highly trained individuals:

Dieul (Reading 270-15): In the one before this we find in that land when the division arose in the land now known as Egypt. The entity then among those who were finally chosen to supervise the educational forces of the period, especially as pertaining to the records kept in the physical application of physical conditions, and the spiritual applications through the religious rites of the temple's setup.

Hence the entity found much dissension through the office imposed on same; for with those that were the counsellors of the ruler, found the entity disfavor with these, as the entity also found disfavor with the attendants in the various temples; for the entity came to be known as the *spy*, or the *telltale*, for either the king, the priest, or the one in charge of the school and the temple. The entity then in the name Dieul...

In the one before this we find in that period when the Atlantean peoples were near the turning of the higher civilized forces as apply to the application of physical and material elements to the use of man. The entity then the one that was first able to *generate* that power since known as the latent force in applied physical beings, or electronic energy as later called. The entity then one in power, position, and gained much in this experience, being able to serve through service given. In the urge as seen, the love of position and power, and innately the love of those of [*bioelectrical qi healing*] *instruments* that would serve mankind.

During the Atlantean era, bioenergetic practices were applied for both destructive and constructive purposes; for warfare and healing alike, while other related wireless technologies were also applied by Atlantean engineers, including the broadcasting of live voice and video transmissions, or *television*:

Ambeno (Reading 813-1): Before that we find the entity was in that called or known as the Atlantean land, during the periods when there was much turmoil and strife from the rejections by many of those laws and tenets of One; when the upheavals began that made for the egress of many from that city of the Poseidon land –or in Poseidia the entity dwelt among those where there was the storage, as it were, of the *motivative* forces in nature from the great crystals that so condensed the lights, the forms, the activities, as to guide not only the ship upon the bosom of the sea but in the air and in many of those now known conveniences for man as in the transmission of the body, as in the transmission of the voice, as in the recording of those activities in what is soon to become a practical thing in so creating the vibrations as to make for television – as it is termed in the present.

The entity then was among the princesses that served the peoples not only of high but of low estate in that particular period of activity in the land. Hence we find with those turmoils that came from without, as the voices of those were raised against those in authority that controlled those activities for their own self-gratification, there were brought trials to the entity and those about same; yet the entity remained true to all of its activities, not deeming it as other than a duty, a duty of love and of service for its fellow man that those powers and the influences of the infinite might be a portion. And though the entity saw much of this turned into self-indulgences, it never became in that experience a portion of the entity's activities; in the name then Ambeno.

The height of Atlantean technological advances also influenced the parallel development of an opposing social polarity composed of those who rejected the spiritual teachings in favor of idol worship, known as Sons of Belial, Bel, Baal, Baalilal, etc. implicated in each of three cataclysms of Atlantis:

Alta-misa (Reading 339-1): In the one before this... the entity was in the Atlantean period when there were those contentions between those of the One faith and those that were of Bel-Ra –or the idol worshippers. The entity then was in the household of the king before the third destruction, and was in the name Alta-misa.

The Hebrew name 'Baalim' means 'false gods', referring to extraterrestrial reptilian humanoids and their use of interspecies hybridization involving *forced human/animal fornication, fetal removal and advanced genetic manipulation to degrade the genetic expression of their followers and the integrity of humanity.*

The remote temporal context of the development of this advanced psychoacoustic society in the Orion pyramids of Giza has been purposefully suppressed by US government agents who have *redacted vital information and entirely altered the precise temporal references given by Cayce under trance.*

The Association of Research and Enlightenment (ARE) was established by the CIA as a front company designed to control the revolutionary information reaching the general public through the psychic readings of Edgar Cayce, especially regarding the vast technological implications of advanced scientific information given by the Source concerning Atlantean psychoacoustic (wave genetics) technologies and the Tesla Gravity Motor (below).



Acting in the covert capacity of military counter-intelligence contractors, the ARE 'research staff' and ARE Press have *disseminated falsified data in the form of fabricated reports, redaction or alteration of the actual reading dates, locations and participants, as well as alteration of ancient timeframes given in various Life Readings* [Cayce E, Cayce G (2006) *'The Complete Edgar Cayce Readings'* ARE Press].

Unfortunately, Edgar Cayce's own sons Hugh Lynn and Edgar Evans have both been fully complicit in corroborating the falsified past life readings data for the CIA organized ARE, and have both been long time employees of various US government agencies: Lt. "Hugh Lynn... is working with the State and [Federal] Government agencies for recreation" (Reading 2824-1, see Reports). Of course, paychecks received from such government jobs amount to government bribery checks for continued complicity in criminal falsifications of Edgar's work, along with life-long appointments on the ARE Board of Directors.

H. L. Cayce and E. E. Cayce have authored a slew of New Age books offering the same false data designed to confuse readers in the name of 'National Security'. Dates given for the 341 *Araaraart* series have been altered to conform to the life of Hugh Lynn Cayce, yet were actually given for an associate of Nikola Tesla who died in early 1926 (husband of Mrs. [2670]). Dates given for the 487 Ajax series have been altered to conform to the life of E. E. Cayce –also a life-long government employee and ARE board member– *yet were originally given for Nikola Tesla decades prior.*

Likewise, the 4666 series of readings for the Tesla Gravity Motor has been falsely attributed to some obscure inventor with a portion of a patent to his name, while the 4666 readings were clearly given for a well known inventor with a great many patents associated with his name. Of course, Edgar Cayce himself had no recollection of giving the readings at all, but relied entirely on the stenographer for his own comprehension of the material being given by the Source through him.

The deceitful purpose of these falsifications involves not only the theft and obfuscation of the inventions of Nikola Tesla, but also served to undermine the soul group that reincarnated to support the development of healing technologies during the modern era through Tesla's work. Deceptions that had effectively deflected public interest in the resonant physics of the Tesla Gravity Motor for 85 years are now giving way to the expanding awareness of the vibratory physics of acoustic levitation.



During another Life Reading, Cayce identified the "application of forces from nature" for construction purposes and global wireless power transmission through the activity of cosmic rays upon the temple structures. This lost ancient knowledge was restored through the wireless inventions of Nikola Tesla:

Ptel-in (Readings 440-1,5): Before this we find the entity was in that land now known as the Egyptian, when there had been trials and turmoils from the conditions that arose politically and from the religious feeling caused by the banishment of the priest.

The entity was among the workers in the native peoples who aided in supplying the peoples those activities that enabled them to apply much of the arts that have been lost to the present day, as to the application of forces from nature in preparing or erecting the buildings in that period. Then the entity was in the name Ptel-in. In such applications the entity was associated with some of the individuals who worked with the king [Araaraart], or the king's council that aided in the building...



Another Life Reading given by Cayce on September 26, 1936 related to the building materials used according to Atlantean stone casting techniques that were applied on the Giza plateau by Ptel-In:

Phar-Ar (Reading 1265-1): Before that we find the entity was in the land now called the Egyptian, during those periods when there were those entering in from the northern land... The entity was of those peoples, and a close associate then of Araaraart as well as Arart and Ra-Ta, and the entity made for the building up of those influences for the archaeological researches as would be called of that day, as well as the preparations of stones, of gold, of all the various forms of building materials. The entity then was in the name Phar-Ar.

The "preparations of stones, of gold, of all the various forms of building materials" refers to the special formulations of synthetic stone integrating finely ground piezoelectric and pyroelectric minerals, as well as ferromagnetic metals such as nickel and iron. A remnant of the Atlantean reconstruction of the Orion pyramids is a broad section of basalt causeway (above) that survived the catastrophic cometary impacts that finally submerged the large island groups of Atlantis ~12,900 years ago (Kennett et al, 2015).



The extremely worn surfaces of the basalt pavement blocks attest to their great antiquity, having been laid down during the period of the Atlantean occupation of the Orion pyramids, being several times the age given by Egyptologists who falsely attribute it to known reconstruction periods of Dynastic Egypt.

Water wear by hundreds of successive inundations of the Nile River has effectively ground the basalt surfaces smooth. Despite the use of modern cement fillers, the severe abrasion patterning evident on the exposed basalt surfaces cannot be attributed to other forms of wear, and immediately implicates an age for the pavement of greater than 20,000 years.

The trance statements of Edgar Cayce are strongly supported by the presence and state of preservation of the existing portions of the large basalt causeway that once encircled the pyramid temples. *In fact, the extreme hardness and density of the Giza basalt pavement blocks exceeds that of all natural basalt.*



Petrographic analyses of the Giza basalts have not been made available to the general public because they consistently identify the artificial origin of these basalt pavement blocks as geopolymer stones that are identical to the synthetic basalt formulations used in construction of the Ohum pyramids of Ecuador!

About 30,000 years ago, pyramid builders in all parts of the world began to apply advanced metallic formulations for preparing synthetic stones such as magnetic granites and magnetic basalts, exhibiting finely ground particles of exotic mineral and metal constituents such as quartz, tourmaline, pyrite, gold, silver, nickel, and iron. *Accurate construction dates for the artificial basalt causeway of the Orion pyramids have been withheld from the public, for they offer definitive confirmation of the Cayce history.*

Artificial pyroelectric stone was directly named as Atlantean 'firestone' (Reading 440-5) invented by the Atlantean leader Ajax of Ode: "the entity then gave to that people the manner of use of the universal forces as may be applied in the way of mechanical construction in a physical plane" (Reading 487-4).





A close look at the interface between the limestone bedrock and the overlying basalt pavement (above) reveals significant details concerning the advanced construction techniques used at this site long ago. The relatively soft limestone bedrock of the Giza plateau was *not* carved flat before the harder basalt layer was added to resurface the causeway. *This fact directly implicates that the basalt surface blocks were poured in situ using synthetic basalt casting processes that have only recently been rediscovered.*

The modern geopolymer chemistry classification of the artificial basalt stonework of the causeway pavements of the Temple of Sacrifice (now erroneously called Khufu's Pyramid) was identified years ago as a sodium/potassium poly(sialate) matrix for rock-based geopolymers (in this case basalt), after rediscovery by Dr. J. Davidovits, and published in *Geopolymer Chemistry and Applications* (2008).

Davidovits's company *Cordi Geopolymère* participated in US- and EU-military financed geochemistry projects Geocistem (1997) and GEOASH (2004–2007), replicating ancient synthetic stone formulations for application to US and EU military infrastructure worldwide, as geopolymer runways for airbases and subterranean installations, etc. Geopolymer foams are now applied for lightweight anti-ballistic shielding.

These applications were foreshadowed by the intuitive work of Canadian inventor Troy Hurtubise, who gained attention for his *Ursus Mark IV* anti-bear suit, *Angelight* and *Godlight* beam devices (2005). Hurtubise has also developed novel geopolymer pastes and foams for fire-proofing, bullet-proof jackets, bomb-proof padding and vehicle body-armor that has outperformed all military-grade gear of its type.

Hurtubise's *Angelight* plasma beam device employed krypton plasma for generating high-intensity X-ray light that renders all matter invisible (as viewed from the direction of the source of the beam), while his *Godlight* healing device generated an HHO plasma beam for rapid cellular regeneration. The *Godlight* device quickly destroyed cancerous tumors over successive treatment periods.

Edgar Cayce's Source specified the same technical means as the advanced plasma technology applied by Atlantean scientists in their magnetic geopolymer temples for bioelectrical healing, genetic purification purposes and for the supplying of all illumination, transportation and electrical power needs:



## (Na, K)-poly(sialate) Rock-Based Geopolymer

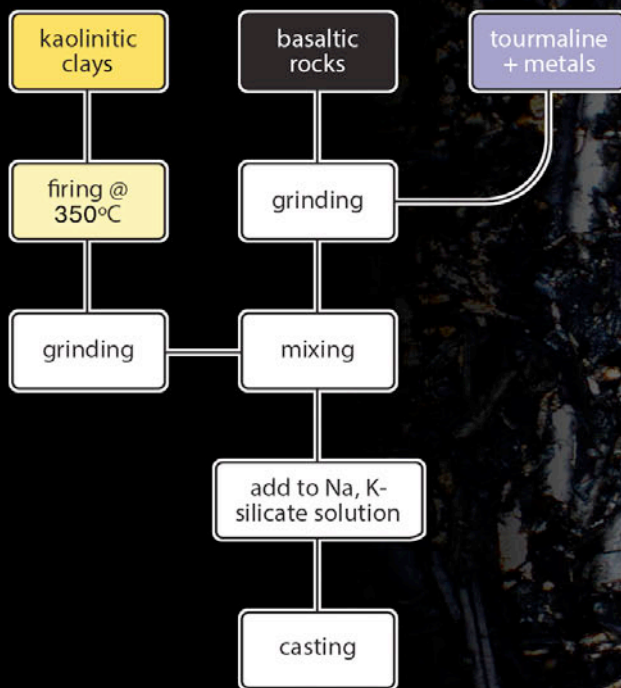

200  $\mu$ m

Asal-Sine (Reading 440-5): As indicated, the entity was associated with those that dealt with the mechanical appliances and their application during the experience. And, as we find, it was a period when there was much that has not even been thought of as yet in the present experiences.

About the **firestone** that was in the experience did the activities of the entity then make those applications that dealt with both the constructive and destructive forces in the period. It would be well that there be given something of a description of this, that it may be better understood by the entity in the present, as to how both constructive and destructive forces were generated by the activity of this stone.

In the center of a building, that today would be said to have been lined with non-conductive metals, or non-conductive stone—something akin to asbestos, with the combined forces of Bakelite or other non-conductors that are now being manufactured in England under a name that is known well...

The building above the stone was oval, or a dome wherein there could be or was the rolling back, so that the activity of the stone was received from the sun's rays, or from the stars; the concentrating of the energies that emanate from bodies that are on fire themselves --with the elements that are found and that are not found in the Earth's atmosphere. The concentration through the prisms or glass, as would be called in the present, was in such a manner that it acted upon the instruments that were connected with the various modes of travel, through induction methods --that made much the character of control as the remote control through radio vibrations or directions would be in the present day; though the manner of the force that was impelled from the stone acted upon the motivating forces in the crafts themselves.

There was the preparation so that when the dome was rolled back there might be little or no hindrance in the application direct to the various crafts that were to be impelled through space, whether in the radius of the visioning of the one eye, as it might be called, or whether directed under water or under other elements or through other elements.

The preparation of this stone [now known as rock-based geopolymers (process outlined above)] was in the hands only of the initiates at the time, and the entity was among those that directed the influences of the radiation that arose in the form of the rays that were invisible to the eye but that acted upon the stones themselves as set in the motivating forces --whether the aircraft that were lifted by the [HHO] gases in the



period or whether guiding the more pleasure vehicles that might pass along close to the Earth, or what would be termed the crafts on the water or under the water. These, then, were impelled by the concentrating of the rays from the stone that was centered in the middle of the power station, or power house...

In the active forces of these the entity brought destructive forces, by the setting up --in various portions of the land-- the character that was to act as **producing the powers** in the various forms of the people's activities in the cities, the towns, the countries surrounding same. These, not intentionally, were *tuned* too high --and brought the second period of destructive forces to the peoples in the land, and broke up the land into the isles that later became the periods when the further destructive forces were brought in the land.

Through the same form of fire the bodies of individuals were **regenerated**, by the burning --through the application of the rays from the stone, the influences that brought destructive forces to an animal organism. Hence the body **rejuvenated** itself often, and remained in that land until the eventual destruction, joining with the peoples that made for the breaking up of the land --or joining with Baalilal at the final destruction of the land. In this the entity lost. At first, it was not the intention nor desire for destructive forces. Later it was for the ascension of power itself.

As to describing the manner of construction of the stone, we find it was a large cylindrical glass (as would be termed today), cut with facets in such a manner that the capstone on top of same made for the centralizing of the power or force that concentrated between the end of the cylinder and the capstone itself.

As indicated, [See 996-12] the records of the manners of construction of same are in three places in the Earth, as it stands today: in the sunken portions of Atlantis, or Poseidia, where a portion of the temples may yet be discovered, under the slime of ages of sea water --near what is known as Bimini, off the coast of Florida. And in the temple records that were in Egypt, where the entity later acted in cooperation with others in preserving the records that came from the land where these had been kept. Also the records that were carried to what is now Yucatan in America, where these stones (that they know so little about) are now -- during the last few months-- *being* uncovered...

Paleolithic use of Atlantean firestone at the Padang Pyramid in Java, Indonesia --as artificial magnetic andesite-- has been radiocarbon dated at ~29,000bp, while the ~34,500-year-old Visoko Pyramids of Bosnia display only non-metallic geopolymers, *as they predate the invention of firestone by Ajax.*

As in the case of the firestone basalt and andesite pyramids of Java, Indonesia, the firestone pyramids of the lands of On, now modern-day Ecuador, represent the outsourcing of Atlantean technology given during the colonization period preceding the evacuations of Poseida and the other large Atlantean islands under threat of tectonic destruction initiated by authorities in the Pyrenees:

Aruhi (Reading 779-9): In the one before this we find in the Egyptian forces, and the entity then in that of the stone collector for the one in the rule, and in the name we find of Aruhi. In this we find the entity one of might and power for a short period, yet in the decided issue taken when the religious rule was disturbed, the entity then in the forces that were banished [with Ra-Ta, etc.] from the land. During that period we find again the entity a cutter of precious stones, especially those in the Temple Worship.

In the one before this we find in the Atlantean rule. The entity then one of high authority, being then the ruler in that land, during the age of advanced forces as seen in Earth's plane. The entity ruled well, developed much, until the... forces of the entering of others from other spheres [or regions], and through the warring of the nations then in that land, the entity became selfish in that last period.

The urge from this is toward those of the arts and especially of that of the work in those of stone, marble, granite, or of elemental forces in same, for under this rule some of the most beautiful buildings were erected in that plane and the entity brought much to the peoples until those destructive forces coming from the rule in the Pyrenees brought the destruction in that land.

In the urges, the greater being then, the desire of an understanding of all force as is applied in mechanical construction in lifting forces, for the entity then was able to assist much to the peoples of that period...

Paleolithic cave-dwellers are well known from the Pyrenees region for their stunning cave murals, yet the hidden presence of pyramids in the Pyrenees mountains is not known today. *Cayce's statements suggest Atlantean pyramids (similar to those of Visoko, Bosnia) may also exist in northern Portugal.*



The presence of Atlantean firestone pyramids in the very regions which Cayce identified as colonized by evacuating Atlanteans, and which have been RC-14 dated to the same time period identified by Cayce –~29,900 years ago– presents staggering implications for the Paleolithic history of the world.

Metallic basalt firestone from Noah's Ark also confirms its widespread use prior to the Great Flood event. A recent assessment of sea level change based on the correlation of dated shoreline materials accommodates Cayce's Great Flood timeline perfectly (Lambeck, 2014). A blue line has been superimposed on the data graphing sea level change over time highlights a sharp peak at 30,000bp, marking the epic Great Flood catastrophe as given by Cayce (below).

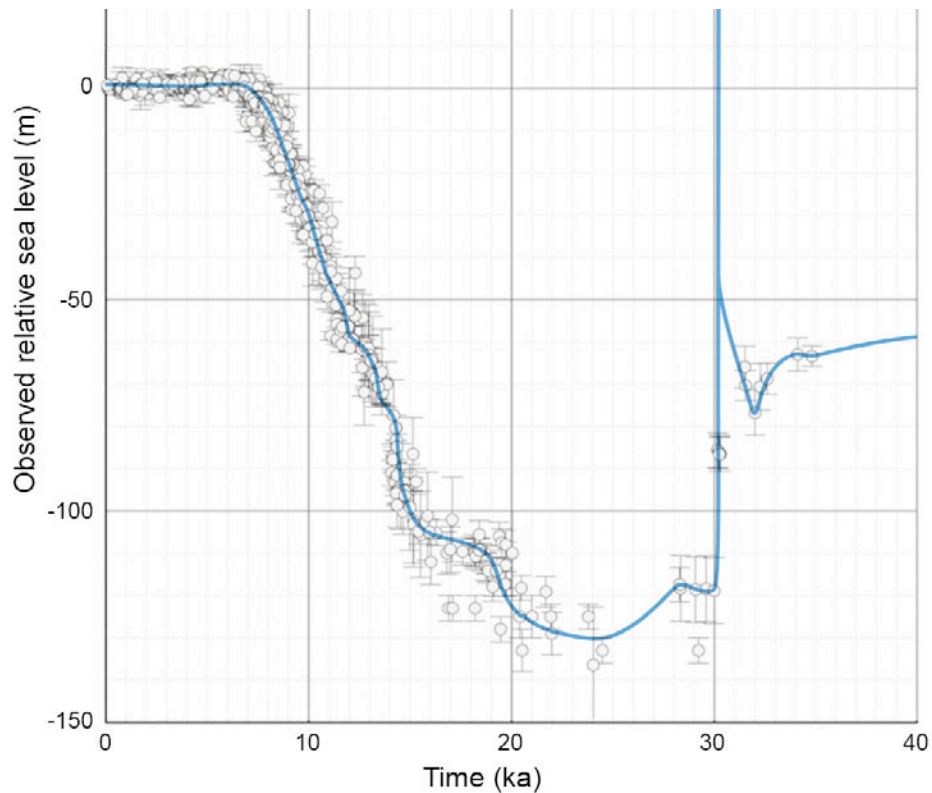

The global paleontological record very strongly supports the Great Flood hypothesis at 30,000bp, as revealed in recent paleo-fauna studies. Isotopic analyses of megafauna bones confirms mammoth populations were decimated 30,000 years ago, having repopulated Eurasia from the Tibetan plateau.

Cayce was specifically asked for an approximate date for the period of the Biblical Great Flood in follow-up questions answered during a psychic reading for Norfolk Study Group #1, conducted on February 17, 1932 (Reading 364-6):

*Q: In relation to the history of Atlantis as presented, at what period did the flood as recorded in the Bible in which Noah took part, occur?*

*A: In the second of the eruptions, or –as is seen– occurred twenty-two thousand plus six thousand years before the Prince of Peace, as time is counted now... [22,000 + 6,000 + 2,000 = 30,000bp]*

This surprising response provided by the trance medium concerning the timeframe of the *second period of eruptions in Atlantis* described as the Deluge in the Bible, was later clarified as having occurred ~30,000 years ago, according to a Life Reading for Thomas Townsend Brown:

Asphar (Reading 470-22): [T]he entity was in Atlantis when there was the second period of disturbance –which would be some twenty-two thousand, five hundred (22,500) years before the periods of the Egyptian activity covered by the Exodus; or it was some twenty-eight thousand (28,000) years before Christ, see? [28,000 + 2,000 = 30,000bp]



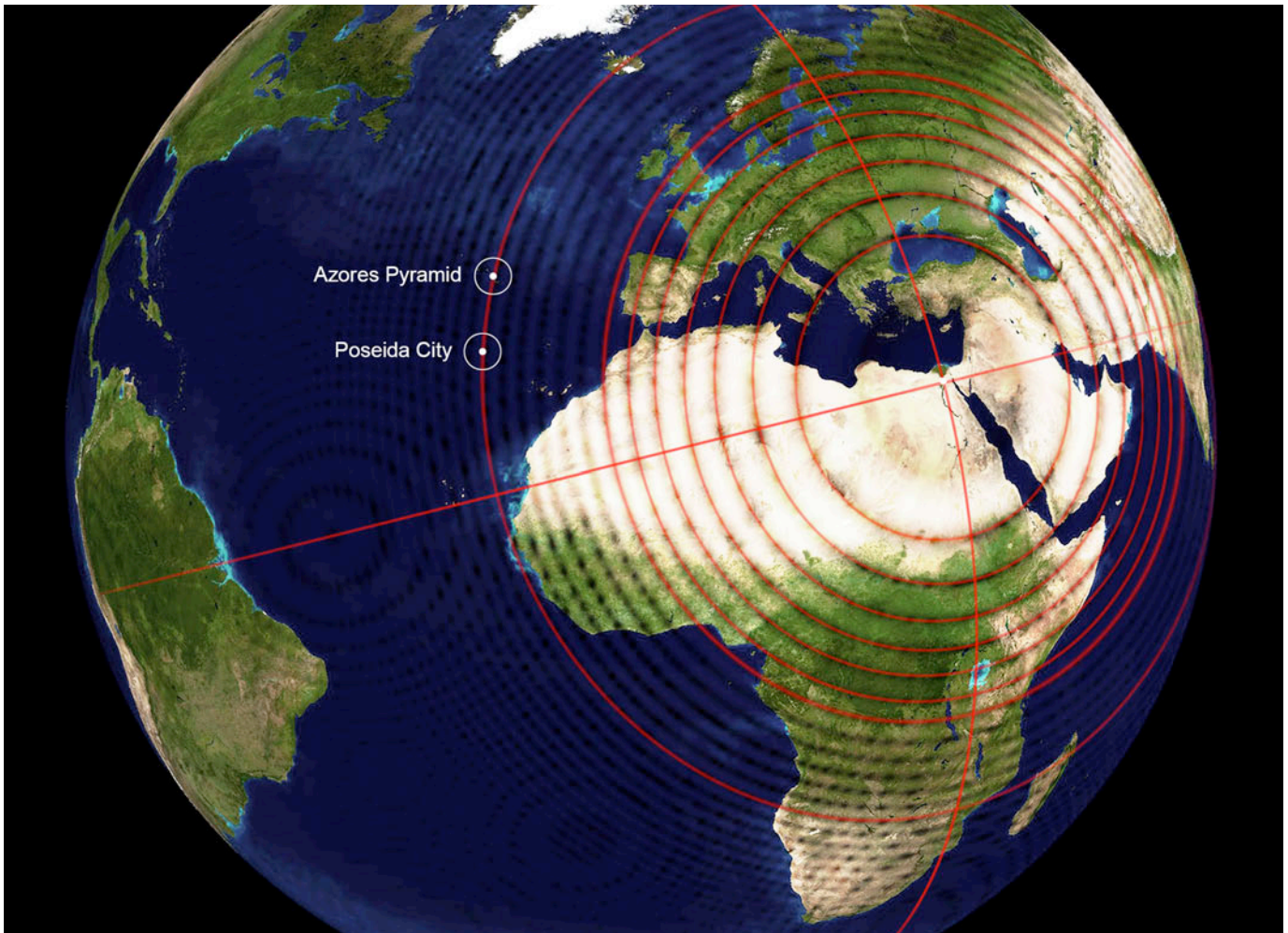

The reconstruction of the Orion pyramids required 30 years, and occurred at ~29,996bp, according to the consistent timeframe given in Readings 470-22 and 341-8 (see pgs. 319-320), prior to the entering of the Atlanteans from Poseida and the reorganization under Ra-Ta after his return from exile.

The catastrophic destruction of the five large islands comprising Atlantis, during the second period of its existence, were predicted by the prophet Ra-Ta in Persia, well before his activity in the Orion pyramids. This confirmed what seismic monitoring had made apparent to the leadership in the afflicted Atlantean lands –*that imminent upheavals were indicated by data streams assessed:*

Xar-pen (Reading 633-2): Before that we find the entity was in the Atlantean land, when there was the breaking up of the isles and it had been given out that those who would or were to be saved must journey forth to the various centers to which the leaders had been given the passports.

The entity was among those who came first to what is now the Pyrenees, and later to the activities –after they had been set up years before– in the Egyptian land. In the name then Xar-pen, the entity gained and lost and gained. For the entity was among the sons of the Law of One, to whom there was given much power.

Evacuation of Atlantis and Poseida City was offered to the leaders of the Sons of the Law of One throughout the Isles, while several regions for emergency emigration were identified, including the Pyrenees area, the Nile region of Egypt, the Yucatan peninsula and the South American lands of On (now Ecuador) and Og or Oz (now Peru). Mass evacuations were preceded by a series of aerial expeditions throughout the globe, lead by Ax-Tell, to prepare each of the selected emigration regions:

Aoun (Reading 1710-3): Before that we find the entity was in the Atlantean land when there was the breaking up of the land, and when there was the journeying of those to the various lands for activities. There we find the entity first coming into what was called the Mayan land, or what is now Yucatan.





With the establishing of the associations of many of the peoples (in which the entity was closely associated in the Atlantean land) in the Pyrenees and in the Egyptian land, the entity was the first –in that period of experience– to cross the waters in the plane or [disc-shaped] air machine of that period (above)...

While there were disputes especially with Ax-Tell and the leaders who made for those activities in the Egyptian land, the entity was sent eventually as the emissary to the land of Said; and in that particular experience the entity, as Aoun, made for the greater associations for the activities in the Egyptian land; joining with those from the land of Saneid and those from what is now the Mongoloid land, as well as those in what is now the Indo-China land.

The advanced genetic healing and physical regeneration practices conducted by the Atlanteans in the Great Pyramid became the focus of global activities during that period of civilization, drawing ambassadors and emissaries from all lands of the Earth. Resettling of Atlanteans in adjacent lands was preceded by several expeditions to prospective regions to establish crucial technology-sharing agreements. This series of aerial expeditions were made in fleets of shining silver discoidal spacecraft of Atlantean build, with navigation calculations made by the mathematician Pek-AI:

Pek-AI (Reading 2677-1): Before that the entity was in the Atlantean land, in those periods when there were the preparations resulting from those activities and disputes between the children of the Law of One and the sons of Belial; so that the various groups were sent to the varied lands.

The entity was among the children of the Law of One, –the mathematician, the one who made preparations for those journeys through the air to the Pyrenees; later, with those establishing of the activities in Egypt, the entity took residence there; becoming associated with Ajax or Ax-Tell in those experiences.

In the name then Pek-AI, the entity made measurements for some of those activities that brought about the buildings in parts of the Nile, as to make for the governing of the waters of same.

Measurement of Fibonacci ratio distance relationships for the placement of water distribution canals and temple structures according to standing wave patterns was applied by Ax-Tell and the other members of the king's building council who oversaw post-flood reconstruction on the Giza plateau. *This technically advanced period of rebuilding activity endowed long lifespans during that era.*

The Atlantean Ax-Tell (or Ajax) was often accompanied by his aid and bodyguard, named Amahaza:

Amahaza (Reading 661-4): The entity then was an aide or a bodyguard (as would be called in the present) to Ax-tell. Then in the name Amahaza, the entity gained and lost; for there were many of the turmoils during the entity's first portion of its sojourn in the Egyptian land. Though young in years, the first portion of its activities in that land made for some dissensions among its own peoples, with the attempt to coordinate the activities of the Egyptians and those peoples who had banished the Priest. And in those attempts for the correlating that made for future activities, the entity made many enemies, many foes.

The special messenger for close communications between Ajax and his contacts in other lands was maintained by the Atlantean Segund, who had been among those emigrants to the Egyptian lands:

Segund (Reading 1681-1): Before that we find the entity was in the Atlantean land. There we find the entity was very close to those in authority; being that one who was the keeper of the portals as well as the messages that were received from the visitation of those from the outer spheres, in the latter part of the entity's experience there. For it was the entity that received the message as to the needs for the dividing of the children of the Law of One for the preservation of the truths of same in other lands.

Hence we find the entity was among those who were as the directors of those expeditions, or the leaving for the many varied lands just before the breaking up of the Atlantean land. Hence the entity outlined in the most part, it might be said, the expedition guided by Ax-Tell and the ones to the Pyrenees and to the Yucatan and to the land of Og.

There we find the entity then gave those communications that were established later by the entity from the Pyrenees, and later again established in the mountains in the Grecian land –and there those messages that called for the meetings of the nations were brought about by the activities of that entity during that sojourn.

Later, with the revivifying of the Priest in Egypt, the entity was among those who set about the unifying of the teachings of the Atlanteans, the Egyptians (as... called today), the Indian, the Indo-Chinan, the Mongoloid and the Aryan peoples. All of those were the activities of the entity, for he was the messenger and the message-bearer –or the means through which transmissions of activities were set up. The name then was Segund.

The sophistication of global communications and rapid aerial transportation during the Atlantean period is made clear in the Life Reading for Segund. Other significant contextual details concerning advanced technologies of that era were given in another Life Reading for 'Is-Ar-Ar-Ra', meaning "waning son (of the) son granting", specifying the ancient name for the Great Pyramid as the 'Temple Beautiful':

Is-Ar-Ar-Ra (Reading 910-4): Before that the entity was in the Egyptian land, during those periods when there were the turmoils and strifes, and when there was the ejection or banishment of the Priest. The entity was among those in the land to which the priest and those with him were banished.

The entity came under those activities, those influences, and returned to the Egyptian land; near to the areas in which there was the Great Pyramid and city; and one that is yet to be uncovered –in a portion of that just beyond the Great Pyramid– was the home of the entity in the latter portion of its sojourn there; a home magnificent, for it was turned to a place where preparations were made for those of both sexes, for their preparations as children, for the activities through the Temple of Sacrifice and the Temple Beautiful.

Then the entity was closely associated with the activities of the Priest, as well as those who coordinated and cooperated with the Priest in establishing the customs in the land. The name then was Is-Ar-Ar-Ra.

*Remarkably, the Source reveals an entire city of Atlantean construction lies untouched below the sand!* The concise history of the height of the Paleo-Sanskrit civilization just after the Second Destruction by flood, given through the mosaic life-patterning of hundreds of Cayce's Life Readings, describes a major schism in the social order of the ruling group that combined the Royal Persian Houses of King Arart and Ra-Ta with the Royal Atlantean House of Ode that had evacuated the sacred city of Poseida:



High Priest Ra-Ta (Readings 294-19,148,149, 5748-2,3): In the one before this we find the entity was in the Egyptian land, when the force of the law was being given to the people, in that one chosen as the highest authority in the mental attributes, acting in the way of the Priest [Ra-Ta] to the people, being the first chosen priest of the cult, as afterward called, among the nations of the world. In the present personality and present plane, we find again many in the Earth's plane... associated with the entity, that were associated with the entity in that plane. Again we find the entity falling in the way of flesh,... this fleshly carnal force brought destructive elements to the entity.

In the present plane we find still that same urge to be overcome in the entity, for there is that innate call and desire in the flesh for those fleshpots again, as called, of Egypt, and the entity needs that to keep the forces of mental and spiritual development ever to press onward to the higher forces.

With the political situation, then, the king [Araaraart] –the young king, then only thirty– gathered about him many that were to act in the capacity of council, a portion of the inner council that ruled on the general circumstances of the peoples as a whole, then the council that had supervision over various parts of departments of the activities of the peoples, as would be termed in one's present surroundings as holding the various offices as a cabinet, the departments being much in that day as they are in the present; for remember, there is nothing in the present that hasn't existed from the first. Only the *form* or the manner of its use being changed, and many an element then used that the art of its use has been lost, as we will see the reason why, and many being rediscovered by those called scientists in the present when in that day it was the common knowledge of the most illiterate, as would be termed in the present.

With the appointing of such a body, to be sure there was much work for Ra-Ta in council that there be kept the ideal or purpose for which this band, this group, had chosen this particular land for the development or manifestation of the forces that were manifesting through the mental or the spiritual man Ra-Ta.

With this giving in... of the king [Arart], to pit or parallel activities of the native with the abilities of his son, or heir, and he himself –the [former] king– acting as a council then *with* Ra-Ta to the inner council, there were the necessities of matching the abilities of the native –as it were– in the various phases of what would be termed in the present as progress. Hence the opening by Araaraart of mines in Ophir, in what was later known as Kadesh, or in the land now called Persia. Also in the land known as Abyssinia, and those portions yet undiscovered or used in the upper lands of the river Nile, there were those mines of the precious stones –as onyx, beryl, sardis, diamond, amethyst, opal, and the pearls that came from the sea near what is now called Madagascar.

In the northern (or then the southern) land of Egypt, those mines that produced quantities –and quantities –and quantities –of gold, silver, iron, lead, zinc, copper, tin, and the like, that these might be matched with those in the valleys of the upper Nile. Also there was the producing of the stonemasons who began gathering materials for the establishing of the residences of the incoming or the king's peoples.

With the gatherings of these, also Ra-Ta began to gather his own people and those that were pointed out to him through the sources from which he received those various injunctions for the establishing of the name forever in the land. Hence, with these, there were the preparations for the temple where there were to be the various forms of worship, as related to the divisions of the penal or moral relationships of the peoples, and what would be termed or called in the present the religious or spiritual relationships.

There were many periods or days required for the building up of the body, as represented by the group that acted in the capacity of the active individuals about the building of these edifices or temples that were to represent then the recreation halls; for the physical attributes were worshipped much more in many ways in this period than the religious are in the present period, and rightly so –though there were the preparations for the spiritual worship that comprised not only the sacrificial altars, which were not as for the offering of sacrifice in the slaying of animal or bird, or beast, or reptile, or man; rather that upon which individuals put their faults and blotted them out with the fires of those forces that were set in motion by Ra-Ta, in the ability to give to each that for which his or her activity were best adapted in the developing of themselves, when they had chosen to give themselves in service in that particular position in which their activity was necessary...

There were also established storehouses, that would be called banks in the present, or places of exchange, that there might be the communications with individuals in varied lands; for even in this period (though much had been lost even by these peoples) was there the exchange of ideas with other lands, as of the Poseidian and Og, as well as the Pyrenean and Sicilian, and those that would now be known as Norway, China, India, Peru and American. These were not their names in that particular period, but from whence there were being gathered a portion of the recreations of the peoples; for the understandings were of one tongue! There had not been as yet the divisions of tongues in *this* particular land. This was yet only in the Atlantean or Poseidian land.

With the gathering of these people and places, there began the erecting of the edifices that were to house not only the peoples, but the Temple of Sacrifice, [and] the Temple of Beauty –that *glorified* the activities of individuals, groups or masses, who had *cleansed* themselves for service. Also the storehouses for the commodities of exchange, as well as that gathered by the peoples to match –as it were, still– one against the other. Hence we find the activities of the priest, or seer, as really a busy life –yet much time was given in keeping self in communion with those that brought the knowledge of that progress made in the spiritual sense in other lands, especially so from Poseida and Og.

In these visitations that were caused, or that necessitated the absenting of the priest from these places, there arose more and more a dissension with those peoples that there was being builded much that was being left to subordinates, as considered by some of the native councilors –and a few also of those that allowed avarice to arise in their own make-up. This brought questioning more and more, and there began to be the use of those things that gradually turned the minds of those associated in the offices that had been set aside by the priest in their activity, in the use of, in the brewing and concocting of drinks that set against the body, set the mind, set the whole fires of physical body against that as had been cleansed by the fires on the altars, as were in the sacrificial temples.

In the third series, or –as they were set aside as periods of ten years, most of those buildings were completed, and when there was the return of Ra-Ta from one of these visits to the mount –where there had been some activities on the part of those that were delving into what was termed the archaeological conditions of those that had lived in the lands in the periods before– and there was found in the temple of sacrifice the aggrandizing of the lusts of the body, rather than those activities that were to be carried on by the sacrificial priests –there arose a mighty turmoil, and with these conditions arising there became greater and greater stress laid upon Ra-Ta, and there were sought various ways and manners in which there might be fault found with the activities of those conditions that surrounded the body, and there arose at that time the first –as may be said– of that saying, "When the devil can't get a man any other way, he sends a woman for him."

Among those, then, of the priests' daughters, was one of the king's favorites –that made for the entertaining of the king and his council, and his visitors– who was more beautiful than the rest, and she [Isris] was induced to gain the favor of the priest through activities of herself in body, and in the manners that would induce some fault to be found. This was not by her own volition, but rather by the counsel of those that made for the persecutions of her own peoples that were being protected by the activities of the body, and divisions arose that were even unknown then to Ra-Ta, for he being among those that trusted all, believed all, and –as it were– for the time the gods laughed at his weakness! ...

The conditions first, then, as political had been set. The conditions as to the buildings (we will call them) in which there was to be carried on this demonstration of the relationships of individuals to individuals, and relationships of individuals as individuals, and as masses, to the Creative Forces.

In the building, then, of the marital relationships that existed, these as we understand, were not much as homes (as seen or understood as individual homes in the present). Rather were there the *appointed* companionships that were to serve their State, their purposes, for the completing of –or competing of– groups or nations one against another, and were rather the matter of the word of the ruler than that of choice of individuals...

This particular relationship did the priest, or Ra-Ta, attempt to change, in that there should be rather the establishing of the definite homes, as were in other lands that had been then visited by this priest, or from any; that these should be rather those of consecrated lives one to another. Hence there was the tendency of the changing or altering of those *forms* of service that were held in the temple, in which there were not only those acts in the activities of individuals in their relationships one with another for the propagation of those peoples, but also those recreations, and those –as would be termed in the present– halls of learning, halls of precept and also of examples.

These, then, as may be understood, required the supervision –with these changes– of a great number of individuals, and –as is seen from that which has been given– individuals in varied capacities served the priests in ministering to those needs of the conditions and relationships of individuals through the temple; for in this particular peoples all births were in this particular hall –or those set aside for same, as were those chambers in which conception was to have taken place, or to take place, for all the various relationships that existed among the peoples; while in the Temple Beautiful we had rather that which pertained to those changes that were wrought in individuals' activities as they set themselves aside, or consecrated themselves (as would be termed in the present) for particular services in the material or mental, or in the commercial world, as well as those that formed or performed their particular activity or service in the Temple Beautiful, or the spiritual portion...



As was seen, the housing of all the female of the whole clan or tribe for the evenings was in the temple, while those of the male that were outside those of the king's *own* household –and this included the king's alone– not any favorite or queen, or closer relationship, for all were in the same building, for they were under State rules. These were in tiers, as we would term today, beautifully laid out –with their halls, that were three and four tiers. The rooms, as would be sized as we would call, were 7 x 9 in their size, with 8 to 10 feet in the height, with those accoutrements for same –their rugs, their blankets, those that were wrought with the hands that made for the couches, for the various activities.

Those that were born in same were immediately, or after three months, taken from their own families and raised in those groups which were confined in other buildings for those purposes. The great chambers or halls that were inter-between were of high tiers, that made for large halls, with the various forms of recreation –as the dance, etc; for, as given, the body was worshipped in this period as sincerely as most of the physical or spiritual worship that may be seen today, for the bodies were changing in their forms as their developments or purifications were effective in those temples, where the consecrations and changes were taking place by the activities of the individuals in their abilities to turn themselves towards (in the mental) the *spiritual* things...

They gradually lost, many feathers from their legs. Many of them lost the hairs from the body, that were gradually taken away. Many gradually began to lose their tails, or their protuberances in their various forms. Many of them gradually lost those forms of the hand and foot, as they were changed from claws –or paws– to those that might be more symmetrical with the body. Hence the activities or the uses of the body, as they became more erect and more active, more shaped to them in their various activities. These were, to be sure, considered as the body beautiful. Beauty as divine; for the divine has brought –and does bring– those various beauties of form or figure to the body, and should be *considered* as it was given so; for "the body is the temple of the living God." True, then, that the various forms or attributes of the body in its symmetry are of the divine inheritance, as was brought about by this ill-forgotten Ra-Ta in this experience.

In the Temple Beautiful, then, we find here the altars where various forms of desire were sacrificed, that brought to the individuals, or persons, or bodies, in the gradual falling away of those things that made for the *animal* activity in the bodies of those that were attempting to so consecrate, so consecrate themselves and consecrate their bodies, their lives, their activities, in this service. Let's don't forget the thesis, or the key for which all of this understanding had come: That there might be a closer relationship of man to the Creator, and of man to man...

Those groups who had the desire for their own offspring, or their associated or associations for the closer relationships with the priest, and those that came into power in their various forms or activities; for, as is seen, with desire –as the cleansing came– there were those abilities of individuals for various activities in various fields of endeavor. Hence there became singers, workers in linen, workers in embroidery, carders, weavers, workers in clay, those in various forms of commercial industry, those in horticulture, those in agriculture, and the various fields; for no merchants then existed, as there was one common store for all.

Here all became changed, with this tumult that arose with the various priests that were in attendance in the various offices, and advantage was taken of the situation by many of those who in their various forms began to *learn*, as it were, a form of war and defense, and there were the gathering then of the young men, the old men, and sides were taken. Still some remained faithful to the priests who remained in the land, and troublesome times arose for many, many suns, until at least nine seasons had passed before there was even the *semblance* of the beginning of a quieting, and that not until there had been definite arrangements made that the priest *would* return and all would be submissive to his mandates; and he became, then, as may be termed in the present, a dictator –or a monarch in his own right...

At that period, man exchanged with the forces in each sphere [or region] that necessary for the propagation of the peoples of the sphere then occupied. In each of the spheres given was the rule set under some individual by this second ruler [Araaraart] in now Egyptian country, and the period when the mind of that ruler brought to self, through the compliance with those Universal Laws ever existent, then that ruler set about to gather those wise men from the various groups to compile those as that ruler felt the necessary understanding to all peoples for the indwelling of the Divine Forces to become understood and to break away from the fear of the animal kingdom then overrunning the Earth...

The rule [of the Priest Ra-Ta] covering the period of a hundred and ninety and nine (199) years, and the entity giving the chance to the peoples, for the study being in the twenty and eighth (28<sup>th</sup>) year, when [he] began to gather the peoples together for this and surrounding himself with those of that land and of the various lands wherein the human life dwelled at that period. The numbers of the people that came together for the purpose then numbering some forty and four (44)...

Then, we have the gathering together then of this group, from the farthest places –forty and four. As we see,... there is the law pertaining to each and every element significant to man's existence considered and given in one manner or form by the groups as gathered at this meeting.

The dramatic social narrative offered by Cayce during those Life Readings (for himself), *provides a minimum lifespan of Ra-Ta approaching 230 years, achieved through the periods of regeneration in the HHO plasma chambers of the Great Pyramid*. The critical commentary given by Cayce under trance had even injected some mirth –by referring to himself in his previous life as Ra-Ta, along with the Atlanteans, as being 'fleshpots' who undermined their own spiritual growth by carnal associations!

The Paleo-Sanskrit name 'Ra-Ta' means '*granting endowing*', referencing his organization and global dissemination of the tenets of the Law of One and the resonant temple practices that elevated the people to spiritual realizations that have not been granted to those priests of our time.

Mention of the advanced geometrical knowledge of the Atlanteans, as well as the physical appearance of various individuals involved in the temple services and the style and coloration of clothing worn in the period, was made in a short series of trance readings for the members of a small prayer group in November, 1939, some of whom had prayed with Ra-Ta in the Temple Beautiful (Readings 281-42,43):

The Priest was an individual who had received inspiration from within. And, realizing that such an influence or force might be given to others in their search for *why* and *what* were their purposes in material life, he then sought out one who might foster such a study in materiality. Thus, from those places that were a portion of what is now called the Carpathias, he came with a great horde, or a great number (as to individual souls, numbering nine hundred), into the land now called Egypt. *Why Egypt?*

This had been determined by that leader or teacher (not physical leader, but spiritual interpreter or guide) as the center of the universal activities of nature, as well as the spiritual forces, and where there might be the least disturbance by the convulsive movements which came about in the Earth through the destruction of Lemuria, Atlantis, and –in later periods– the flood.

What were the factors, ye ask, which determined this in his mind? Or from what concept did the entity gain that knowledge? Was it just a concept, just a revelation, just a physical analysis, or what? When the lines about the Earth are considered from the mathematical precisions, it will be found that the center is nigh unto where the Great Pyramid, which was begun then, is still located.

Then, there were the mathematical, the astrological and the numerological indications, as well as the individual urge. Ye say, then, such an entity was a god! No. No, –ye only say that because there is the misunderstanding of what were the characters or types of spiritual evolution as related to *physical* evolution in the Earth at that period.

As an illustration (this merely illustrating, now): It is hard for an individual, no matter how learned he may be, to conceive of the activities that exist only three miles above the Earth. Why? Because there are no faculties within the individual entity in the present *capable* of conceiving that which is not represented within his individual self. Yea, –but the individual of that period was not so closely knit in matter. Thus the activities of the realms of relativity of force, relativity of attraction in the universe, *were* an experience of the souls manifesting in the Earth at that period, see?

Thus we find that the experiences of individuals of the period, seeking for the understanding as to the evolution of the souls of men, might be compared to the minds of individuals in the present who are seeking an understanding as to man's use of physical or atomical structure in his own relationships. Then, the individual of that experience or period was not necessarily one other than a soul or entity seeking the knowledge as to the relationship of that which would sustain and gain *for* man the abilities not only to continue the physical evolution but the spiritual or soul evolution as well.

Such an one, then, was Ra, –or Ra-Ta. (Study this, or you won't understand it!)

Then, with his entrance into Egypt, with the proper place, the proper relationships with that activity, –which was indicated by the willingness of the peoples of that land, in the greater extent, to be led into those activities for the physical as well as the mental and spiritual developments of the period, –we find that there were the activities in which the King with his Council found fault with the actions of the Priest, because of the indications that there was not the adherence to that he demanded of others, in his own life or experience.



Then there entered what may be termed the desire of a group to *impose* the teachings on the people; not to teach man by experience (as was the Priest's desire...) what relationships he must bear, in every extent and phase of his life, to his fellow man; that he may understand through same the phases of the mind, the phases of the soul. Ye see it only in physical reactions. So did many of those who were in authority in Egypt.

Hence there came the banishment of the Priest, with the companion, as well as the many numbers of those who chose to be banished into the Abyssinian land, who were attracted by the natural intent and purpose of the Priest, —not only those of his own peoples but many of the Natives. Then there followed the nine years in banishment; as well as the periods of the uprisings of the Natives in rebellion, and also those of the King's own household in the Ibex; as well as the entrance into Egypt of the peoples from the Atlantean land, which had begun the breaking up —as had been told by that entity, the Priest...

When the Atlanteans in that experience began to influence the spiritual and moral life of the Egyptians, under those turmoils which had arisen through the Rebellions as indicated, there came that desire, that purpose —especially on the part of the Natives, as well as those who had been adherents partly to the tenets of the Priest— that the Priest be returned, that there might be a better understanding. For the Native leaders, especially, realized that their own activities or representation in the spiritual, moral and religious life would be destroyed if there was the adhering to the tenets being presented by the Atlanteans.

And, as might be termed in the present, some indicated that the Priest alone would be a match for those activities of some of the stronger or more forward Atlanteans. For they had brought with them (as had the Priest) many *Things*, or individuals, or entities, that were without purpose, —or merely automatons, to labor or act for the leaders in the various spheres of activity. And, as the Natives found, such beings were being classified or judged to be such as many of the Natives of the land.

Hence there were overtures made to the ruler, and to those in authority with same, that the Priest be recalled. And thus we had the entering in of those activities as were begun as related to many of those who are associated in the Prayer Group work in the present; many here, as well as many others in varied experiences or places of activity in the material world in the present.

With the return of the Priest there began the choosing as to who was to be considered in authority, in the spiritual precepts. And there was the activity of the Priest in choosing entities, individuals from all walks of life, all stations, —whether in authority in the political or the economic, or the general affairs of the land.

Thus, as has been indicated, there arose the needs for the Temple of Sacrifice, where entities, individuals, might offer themselves for the purification of their bodies, that they first might be channels through which there might come entities, souls, manifesting in the Earth with the entire activity of body, mind, soul. It was the same intent as had been the purpose of the Priest, in the choice of that individual through whom the pure race, the pure activities of a better purpose might be made manifest.

This, to be sure, caused a great deal of discussion, dissension, among the leaders in those groups of the Atlanteans. Thus, as has been indicated, there were the needs for the Priest to enter into that period of meditation, of setting himself aside, purifying through continuous prayer, continuous seeking, continuous opening of those forces. And, as we have indicated, there was then much less of that interference that arises from carnal forces as manifested in material associations.

Thus we had the Priest's rejuvenation, or the turning back of age as it were, or those conditions which would hinder the activities. And this began that period in which even members of the present Prayer Group prayed and meditated with the entity; not in companionship, to be sure, but in their *own* desire that there might be a unifying of the purposes, the desires. And with these expressions there were those who chose the activities that were set in motion for the purifying of their bodies, that there might be the purifying of physical conditions which had been and were being affected by the emotional forces, or the carnal influences about them in the experience.

Such activities might be best expressed or explained by comparing same to the present hospitalizations where there might be operative measures used for the removal of such as tumors, breaks, growths or the like.

After the purification (which took some six-and-a-half years...), there began the classifying of services of individuals in their activity through the various offices that were undertaken during that period of the greater prosperity through the Egyptian experience. For there was not only the adding to the monuments, but the Atlanteans aided in their activities with the creating of that called the Pyramid, with its records of events of the Earth through its activity in all of the ages to that [Aquarian Age] in which the new dispensation is to come.



Then, with such activities, the various groups began their preparations through not only the Temple of Sacrifice but the Temple Beautiful also. The Temple of Sacrifice was a physical experience, while the Temple Beautiful was rather of the mental, –in which there was the spiritualization– not idolizing, but crystallizing of activities or services to a special purpose, –or specializing in preparation for given offices of activity.

An intriguing reference was made by the Source to "that [Aquarian Age] in which the new dispensation is to come". Indications from extraterrestrial contactors support the functioning of the pyramids as being inextricably linked with a binary stellar period of 36,666.66... years, corresponding to 3,333.33... solar cycles of 11 years. These figures were known to Atlantean astronomers, whose sacred calendar system was inherited by the Mayan culture that marked the solar maximum of December 21, 2012, with the elapse of their Baktun long count cycle. *The remaining  $\frac{1}{3}$  of a solar cycle amounts to a period of 3.66 years before the Magnetic Reversal and Galactic Superwave arrival in the latter months of 2016.*

The dispensation of life-force from the pyramids that enabled the high development of thought forces, or mental forces during the reign of Araaraart, Ra-Ta and the Atlanteans in Egypt was related in another Life Reading given by Cayce for a woman who had been the interior decorator of the pyramids of Giza:

Iszeiu (Readings 255-5,12, 275-38): In the one before this we find in that land now known as the Egyptian, during that period when there were the reconstructive forces as to the rebuilding or the replenishing of man's correlation of thought, and the studying of the relationships to individuals and the relationships to the universal or the divine from within. The entity was then among those who waited upon the priest in the temple, and *especially* as to those *hangings* of the temple.

The entity was among those who first wove the *colored* patterns or papyrus in the various tapestries, or in linen brocade. The entity still has an eye single to the *patterns* of *peculiar* design, *especially* turning to those of the lotus and scarab, which were the forces that were considered in that experience. In the name Iszeiu, the entity gained throughout this experience, not only in the mental *and* the cosmic or soul development but in the manifested way in which individuals were aided by the entity in the services rendered...



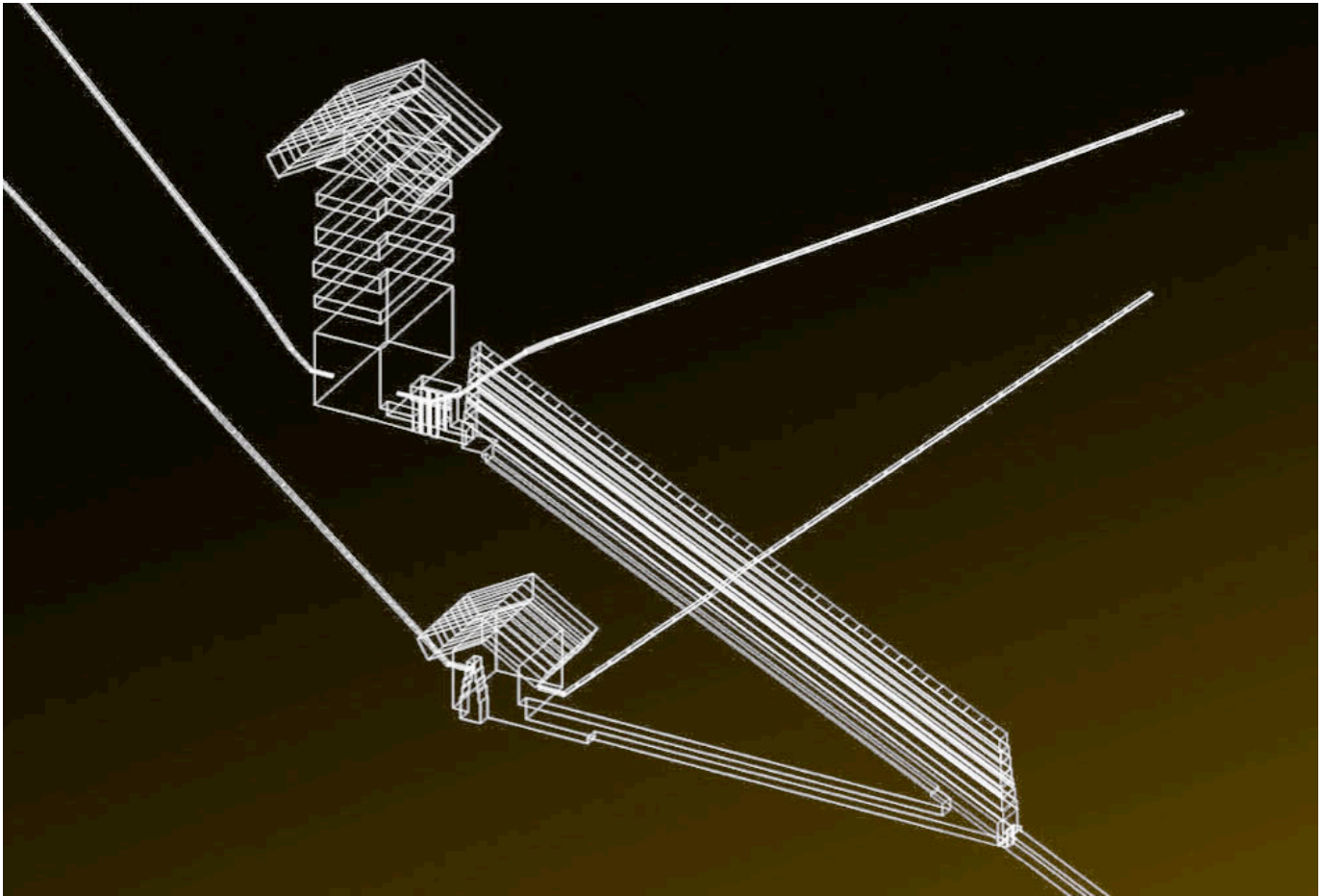

*Q: Did the entity develop at that time any psychic abilities?*

*A: Intuitive influences, that were the greater thought or activity. Words here fail to express just what is intended to give, but the Atlanteans were a *thought* people, those of an intuitive influence. In the associations in the teachings, in the relations at the time, combined with those efforts of the regenerated or renewed Priest (which retrieved, which gave, which meted out to the peoples in the period the tenets, the lessons that became practical laws in the experience), the entity then developed that which is today termed intuition.*

*By the mention of an incident or fact, the entity in the present more often sees the end of same without knowing just how, where, or being able to give any definite details. But more *often* it is correct. Intuition. The faculty. It is so often misunderstood. Psychic forces, psychic development, are so often misunderstood. Psychic should be applied rather to the soul mind or soul body, than merely to –as is the more often deduced– the *mental* activities of an entity, a soul, a body...*

*With the rebellion of the natives, the elder king (Arart) put the son (Araaraart) on the throne to match wits politically with the native Aarart, in the establishing of the political powers and rule in the land. And with this establishing came that period when the priest (Ra-Ta) broke the law that was set by him concerning the number of wives accorded or given to the priest. And this brought first the political uprising. Then the religious war. And the priest with the princess (Isris) was banished, with all those that adhered to the priest's activity, including the aid to the priest (Hept-supht) –to the Libyan land. There we find the first establishings of the land as a place for carrying on that the priest had given in the way of man's knowing his relationships to the Creative Forces.*

*In this activity Ai-Si and El-Tpan, natives of the Libyan land, became followers of the priest. The children of the priest, Ra-La-Ral and Iso, were left in the land of Egypt as political hostages, and religious hostages. The activities of the native Iszeiu, in gathering much from that which had been given by the Atlanteans, established what would be termed today a school and an orphanage for the children of the land...*

*Q: Describe the physical appearance of each at their height of spiritual development.*

A: The priest in body, Ra-Ta... in the height of the development was at the regeneration, or when over a hundred years [of age] in the Earth. Six feet one inch tall, weighing –what in the present would be called– a hundred and eighty-one pounds. Fair of face, not too much hair on the head nor too much on the face or body. In color nearly white, only sun or air tanned.

The king [Araaraart] - five feet eleven inches tall, weighing a hundred and seventy pounds. Fair of face. No hair on the head in the latter portion, or at the height of the development in the experience. Keen of eye, blue in color; and of speech rather quick.

Ra-La-Ral - five feet ten and a half inches, a hundred and fifty pounds, and among those peoples of the men the fairer of skin, with dark hair and gray eyes; in manner quick and alert...

Iszeiu - five feet four inches in height. Bronze when beginning in the service, the pure white when cleansed, in color. In the cleansing the [unwanted genetic] conditions cleansed from body. Fair of hair, blue eyes, ever active in all its associations –as needs be for the activities in the experience...

The child Iso - fair of body, of hair –only four and a half when passing on, through sorrow of separation...

As to the dress of the day, whether in the temple service or otherwise, this was always of linen –and in the manner as indicated, in the color as indicated, white and purple. The men and women were not much different in the manner of dress, save as in the Atlanteans who wore trousers when they came and coats, though much shorter or longer according to their class or distinction of their class. The king in his better moments was clad in the linens and the purples, and in the higher developments no change from the subjects at service.

*Q: In what kind of vehicles did the priest and his retinue return to Egypt after the banishment?*

A: In what would be called chariots driven by the gases [from water vapor, forming HHO plasma]; for the Atlanteans prepared those that brought these back. The followers were on the camels and the animals that were used in the service during that period...

Here, the Akashic Source uses the Biblical term 'chariots' (ie. 'chariots of fire') for the shining plasma ships of the Atlanteans that transported Ra-Ta, Isris and their children born in exile from Abyssinia, or present-day Libya, back to the Orion temples at Giza. The banishment period of the Priest was enforced for only nine years before reconciliation allowed the return of Ra-Ta to the Giza plateau.

The Source stated that after the takeover of the Nile River region by King Arart, he and his wife Isis immediately began special purification, reproduction and waterbirthing practices in the Great Pyramid learned from the Atlanteans, resulting in the birth of their son Araaraart less than one year later. King Arart ruled for 17 more years before abdicating the throne to his 16-year-old son Araaraart, who ruled until he was 114 years of age, benefitting often from rejuvenation periods in the Temple Beautiful.

An inspired description of the excellent leadership skills of King Araaraart was given during a series of follow-up Life Readings given for [341], relating the lofty spiritual goals of the Atlanteans in Egypt:

King Araaraart (Reading 341-24): As is seen in the experience in the Egyptian appearance, or Araaraart: Being the leader, or one in power –as man would classify such exalted position– yet being servant of all he became *master* of all, through the ability to serve and to give others the opportunity to express, manifest, and give –in active action– their expression of laud and praise to the faith as founded through the ensemble of the entity in and during that sojourn.

The position as that of ruler coming in the youth –ruling, or leading and guiding those peoples for *many* years, correlating the activities of thought –and through thought the mind, and physical activity of leaders– towards *One concept* of truth toward relationship of man to the Maker, and Maker's relationship to man. Bringing many who were antagonistic to others –in position, in caste, in political– to the one way, one manner of seeing the relationship of the Creative energy to the man activity in the Earth's plane.

Another ongoing project taken over by the young king Araaraart concerned the massive reconstruction efforts begun by his father, in refaçading the three pyramids of the Giza plateau (forming the constellation pattern of Orion's Belt) immediately following the recession of the torrential floodwaters that had badly damaged the outermost layer of casing stones on each pyramid.





The Cayce Life Readings also provide special information regarding passageways and chambers in the Great Pyramid that were certainly not public knowledge during the 1930s, and have remained hidden until only recently! In November of 2015, exciting news reports announced the presence of a significant thermal anomaly at ground level in the northeast corner of the Great Pyramid, or Temple Beautiful (below). An obvious question immediately arises: Why has this information not been previously made public, considering infrared camera technology has been available to researchers for several decades?

The concise answer to this surprising quandary concerning the Egyptian government cover-up of the thermal anomaly until 2015 is plainly given in the Cayce material, directly confirming the authenticity of his psychic readings. The heat signature belies the presence of a burial chamber in the northeast corner of the pyramid, as constructed by King Azorut, grandson of King Araaraart (Reading 341-8):

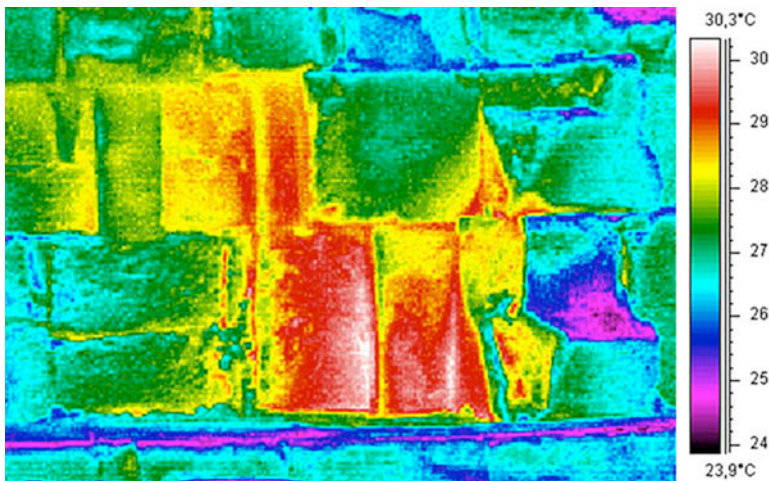

The entity [Araaraart was entombed], then, in the upper chamber of the northeast corner of the first pyramid builded, there placed by the grandson, the king who afterward ascended to the throne in Egypt –Azorut (IV).

Of course, no mention of this crucial data provided through the psychic medium has ever been included in the corporate media disseminated news reports on the subject, as it implicates the criminality of the Egyptian government in concealing the presence of Araaraart's tomb for decades after its initial discovery –*in order to deny the accuracy and significance of the Cayce readings, which provide the actual history of the pyramids.*



Reconstruction of the badly damaged interior chambers of all three pyramids was also accomplished during the initial period of Araaraart's reign, having remained largely unchanged for nearly 30,000 years. This also resolves the fact that no inscriptions mark the walls of the interior chambers, unlike those temples constructed ~5,000–3,000 years ago by the Dynastic Pharaohs of Egypt.

The word 'reconstruction' is used by Cayce because the original building of the Orion pyramids occurred ~73,340 years ago, according to other validated extraterrestrial sources of information on this intriguing subject. The extreme age of the Great Pyramid also explains why the tectonic deviation of its base orientation from the cardinal directions is greater than that of the Sun Pyramid in Visoko, Bosnia, which dates to ~34,500bp –just less than half of the age of the Orion pyramids of Egypt.



The function of each of these Paleolithic structures involved generation of HHO plasma (orbs, above) within the interior chambers for biorhythmic and biophotonic healing of the human body. Rapid physical regeneration of the body's cells allowed for extended human lifespans of up to 250 years, enjoyed by those in the Temple Beautiful and the Temple of Sacrifice, were induced through infrasound resonance techniques facilitating special waterbirthing practices conferring genetic purification: "*all births were in this particular hall –or those set aside for same, as were those chambers in which conception was... to take place, for all the various relationships that existed among the peoples*" (Reading 294-149).

While it was common among these long-lived peoples to bear over a dozen descendants, the unusual situation concerning the many sons of the House of Ode caused some difficulties during the period, as given during the Life Reading for a young housewife conducted on April 12, 1938. Cayce gave her name in a previous life during the Ra-Ta period as 'Is-Hu-Ma', meaning "waning receptive state":

Ishuma of Ode (Reading 1523-4,14): Before that we find the entity in the Atlantean land, when there was the *second* period of the upheavals in the land. The entity was then a priestess in the Temple of Light, the temple in which there were the activities in associations with the Law of One. The entity held such activities not so close as some, and not so close as the priests especially of the older ones judged she should. For the entity consorted with those who were, to the priests, questioned; and the entity during that experience had seventeen sons by seventeen *different* men!

These brought those activities of many disturbing forces, yet never were the priests –either of Belial or of the Law of One– able to prevent the entity, as Ishuma, from leading in the activities in the Temple of Light. Hence turmoils were caused... Though questioned oft as to its lack of centralization, yet each leading –as the sons in its rule in the Earth– towards singleness of purpose from the life.



## Partial Genealogy of Atlanteans at the Orion Pyramids ~29,900bp

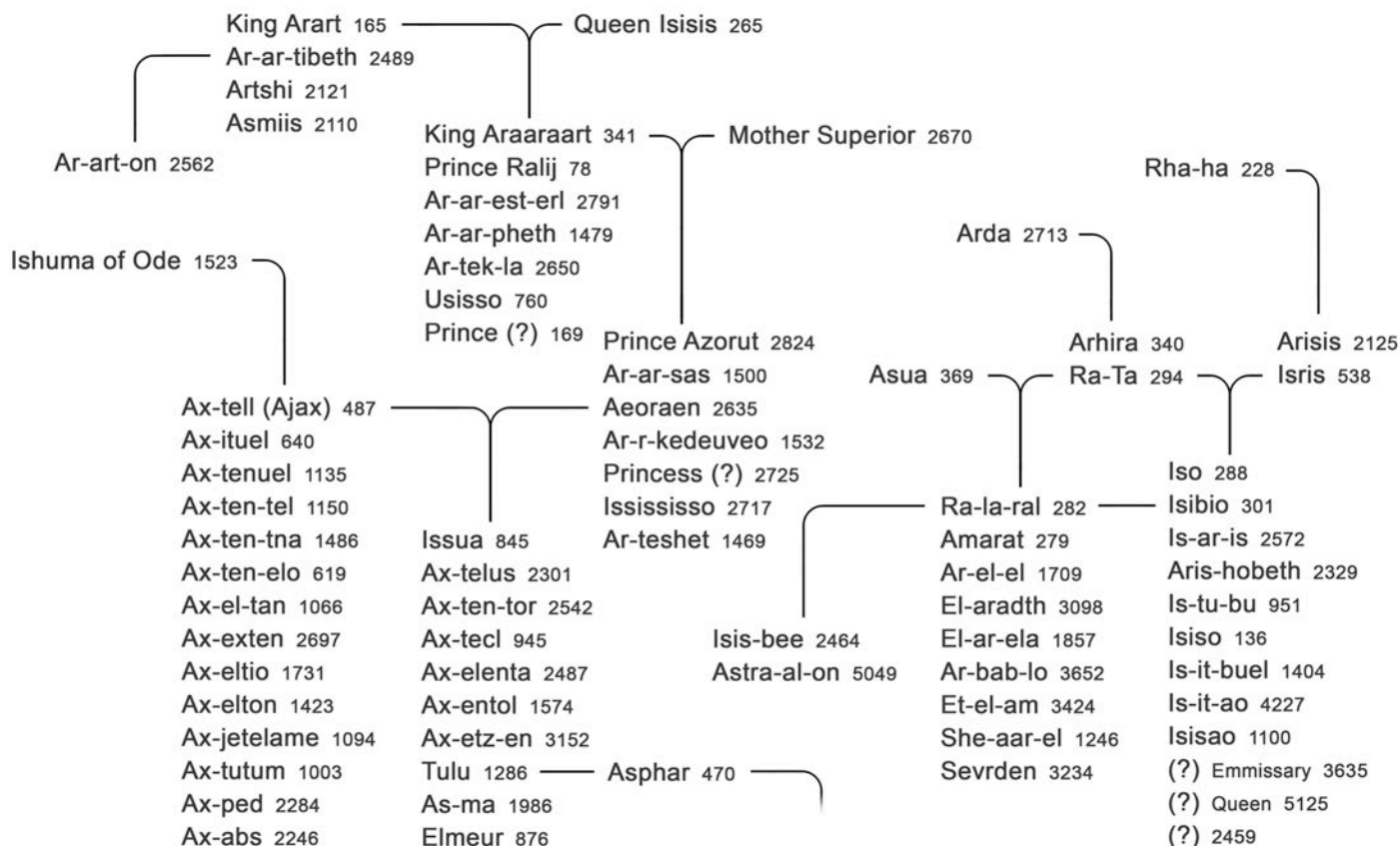

Apparently, children born out of wedlock were not ostracized from Atlantean society, yet the standard of marriage was upheld to prevent the accumulation of multiple wives. Banishment of the Priest Ra-Ta and Priestess Isris was enforced to bring order to adulterous tendencies that threatened their peaceful life in the temples, as indicated in Life Readings given for Edgar Cayce himself, the incarnation of Ra-Ta.

The complex social dynamics of the Sons of the Law of One in the post-flood Egyptian period have been outlined in a partial genealogy chart of Atlanteans at the Orion Pyramids ~29,900bp (above).

Marriage between half-siblings (sharing the same father or mother) was, however, deemed acceptable to the Atlanteans in Egypt, as occurred in the case of the son of Asua and Ra-Ta, named Ra-La-Ral, who married his half-sister Isibio, daughter of Isris and Ra-Ta. The complexity of genealogical lineages of this group is the direct result of having long lifespans of ~200 years –and producing so very many offspring.

The political use of wedlock between the Atlantean Houses fostered unity among the large social group, as mentioned in the recapitulation of the political marriage of Ax-Tell of Ode to Aeoraen, daughter of King Araaraart, as given in a Life Reading for the present-day companion of Nikola Tesla:

Princess Aeoraen (Reading 2635-1): Before that the entity was in the Egyptian land, during those periods when there had been the rebellions and those activities that had divided the people or brought about the periods of rebellion, with the entrance of the peoples from the Atlantean land.

We find that this entity was that influence which brought about a union of strength, by those activities in which the leader of the Atlanteans –Ax-Tell or Ajax [487, Nikola Tesla] (for he was known by both names)– became the companion of this entity, as the daughter of the Young King [Araaraart] in that land. This brought a closer uniting of the efforts of those peoples, and the first opportunity for bringing peace out of chaos.

Also it may be said that this was the beginning of those activities from which many a turmoil has arisen, as well as many an understanding, –by the union of opposing forces through wedlock... The name then was Ae-or-aen, –and, as indicated by the sounds, that entity who headed much of that pertaining to music and art in that period.

King Arart (Reading 165-2): In the one before this we find in that period when divisions rose in the land now known as Egyptian. The entity then among those that counseled with the ruler, being the *father* of that ruler who set the house in order, being then in the kingdom of the palace and coming from the north country subdued the natives, and establishing the kingdom upon which the foundations were laid for the first of the manifested study of man's relation to man and God's relation to man, establishing same as was carried on by the young ruler, even *during* the king's own lifetime, being among those that counseled for the return of the priest and the re-establishing of the school or church, and the assistant to that counselor that gave the tenets to the people, even though the counselor was the native.

Prince Ar-ar-tibeth (Reading 2489-1): Before that the entity was in the Egyptian land, during those periods when there were those turmoils and strifes which eventually brought about the banishment of the priest.

The entity was not of those that would be called advisors to the King, but a brother of the Young King's father. Thus the entity was an influence, a power during that experience, but in the capacities for the activities in the making of linens, the making of paper, the making of those products for the conveniences of the peoples. Such were the entity's activities.

Thus, though there arose turmoils, the entity kept steadily on at those attempts to improve the surroundings for the activities of the natives, also the Atlanteans, as well as those who brought about other rebellions. When there was the reestablishing of the activities with the return of the Priest, one of the chief factors became that of vocational guidance. And the entity then –as Ar-Ar-Tibeth– acted in the capacity of directing the vocational guidance of those purified in the Temple of Sacrifice, as well as those who –by their practical selves– made application of those tenets throughout the experience.

Prince Ar-art-on (Reading 2562-1): Before that the entity was in the Egyptian land, when there were those impelling forces causing the coalition of groups for individual service; following the activities of the King in banishing those from the land, and the activities of others in aiding to give counsel for what might be called the vocational guidance –or the preparation of bodies by active service in the Temples of Sacrifice and the training that was a part of the Temple Beautiful.

Thus we find there were rather the confusing activities, –and these are manifested in the present; yet the entity has a mathematical turn of mind, and a very positive nature as to faults as well as to the virtues... The name then was Ar-Art-On; hence the entity was a close relation, being a cousin, of the Young King who was in power.

Prince Artshi (Reading 2121-2): In the one then before this we find in that land now known as the Egyptian land, and during those periods when there were the interchanging of those of the white, the red, the black...

The entity then among those that set up that *rule* in the Egyptian land that partook of those experiences of the various peoples in the various lands; *building* same rather during the period of peace between the many tribes of the many lands, and the one second before that of the invasion of Arart into the same lands; for the entity was then the uncle of that one who led into that land that made for many changes. In the name [then,] Artshi.

Princess Asmiis (Reading 2110-1): In the one before this we find in that land now known as the Egyptian, and during that period when there were the turmoils from the uprising from the banishing of the priest.

The entity was then among those of the household of the leader, and a sister to Arart in this experience, gaining through those associations; for the entity burned out much that hindered in the Temple Beautiful, and aided in setting those chosen ones in the right way and manner. In the name Asmiis.

The entity gained through the experience, losing only in the first portion, and the entity –as the princess of those lands that were so blessed by the banishing of the priest– came into power through the return, and being rejuvenated with that priest in the upbuilding of the land there in that place and in the close surrounding lands.

Queen Isis (Reading 265-1,2): In the one before this we find in the land of the Egyptians when the second king was in the rule. [Ra-Ta period 29,850bp] The entity then was in the household of that ruler, and was submerged by the rule of that force, or that ruler... [as] Isis,... the Queen or the wife of the first ruler. [Wife of Arart [165]]

King Araaraart (Readings 341-8,9,10): In the one before this we find in the land of now Egyptian. Then in the second king or the ruler of that land [Ra Ta period], and the laws and the religions then just being established. The entity then assisted in giving much to these peoples. The foundation of the truth of the relations of earthly individuals with the High God of Heavens.



The entity then in the name as called Araaraart. In this entity we find that the first temples of sacrifice were builded, and the offerings of blood were first made, and the monuments of the things afterward becoming a stumbling block, yet in the entity's day the means of representing to the peoples the approach to the indwelling of that not made with hands...

Araaraart's time, as we find is, as counted by man, eleven thousand plus sixteen thousand years before the Prince of Peace (Christ) came into this land. [11,000 + 16,000 + 2,000 = 29,000bp]

As to that accomplished, we find this in one of the highest civilizations of this country in its present position, for we find this same country had been submerged for nearly a quarter of a million years since the civilization had been in this portion of country, and the peoples as had overrun the country in the various changes by invasions from the east and north, and this ruler, Araaraart, being then the second of the northern kings, and followed in the rule of the father, Arart, and began the rule, or took the position as the leader in his sixteenth (16th) year and ruled over these peoples for ninety-eight (98) years.

The country, as we find, was brought to a higher state of understanding with the surrounding nations, and there was much of the religious ceremonies practiced in this time, much of this being brought in from the northern country and of the religions as existed in this same country through the religion of that of the one taken as the companion, for there were many taken, and with the unearthing of the tribal rites and ceremonies, the coalition of these truths we find were correlated with these peoples as were gathered about this ruler, and much of the architectural forces were set in motion. As we see, the first foundations of the emblematical condition as is set in the sphinx was begun in this rule, for this, as we see, has remained the mystery of the ages...

*Q: Was this ruler, Araaraart, [341] a native of this [Egyptian] country?*

A: A native of this country, though the father the native of the North country, for this is how the second rule came in this country under this line of rulers, and remained same until the insurging forces from the Eastern hills came in many, many, many years later.

*Q: Were sacrifices offered by the High Priest, Ra-Ta? [294]*

A: No. Sacrifice offered by the Sacrificial Priests, High Priests being those who waited on the peoples, only offering the emblematical for the King and King's favorites...

*Q: What did this High Priest Ra-Ta [294] do to cause disfavor in the eyes of the ruler Araaraart? [341]*

A: It being permissible for the Priest [294] to have only one wife, and this High Priest taking of the daughters of the second sacrificial priest and a favorite [538] to the King, [341] as the Concubine to the Priest, [294] this brought in the forces of rebellion, and the banishment when the offspring [288] was presented in the Temple.

*Q: Was this priest Rhaha [228], second priest and father of Isris [538], the one who took the place of Ra-Ta?*

A: High Priest but not a sacrificial priest. This priest [was] the one who takes the place of High Priest. Second in the High Priests, such as is seen in the same line as given.

*Q: To what age did Iso [288] live, and what was the connection of this body with the King? [341] Was she banished with the parents? (Ra-Ta [294] and Isris [538])*

A: This body, Iso [288], we see, [died] in the fourth to fifth year. Not banished to hills. Kept by the King, as for the respect of the mother, the favorite, [538], and kept in the house of the Sun, or in the Sun Temple under that rule, and this brought the constant consternation to the King, as to whether he was justifiable in banishment, or would not this have been better other ways. Listened, however, to the Councillor Asraio [953] who sought this banishment. [See 341-10, Par. R3.]

Prince Ralij (Reading 78-1): In the one before this we find in the days of the second rule in now Egypt, when the entity then in the brother of the ruler [Araaraart] who gave the first laws to the peoples of the indwelling of the Higher Forces as might be manifest in the Earth's plane.

The entity then in the name of Ralij and was first the hindrance to the brother and later the assistant, when the laws began to take shape in that country and the effects of same became manifest. [See 341-9, Par. 8-A] In the present entity these personalities become then exhibited: The ability to study conditions as are presented and withhold criticism until the truth of same is either shown or disproved in same, and the ability to apply mental forces in physical and in spiritual development.

Princess Ar-ar-est-erl (Reading 2791-1): Before that the entity was in the Egyptian land, when there were those turmoils and strifes. The entity was a sister of the King, that was pitted against the Natives, as well as those that brought about those separations in the activities of the Priest.

But when there were those turmoils that arose by the King's household rebelling, when the Natives and the Atlanteans brought those disturbing factors, the entity was among those who made overtures for the return of the Priest. And there we find the abilities of the entity as directing the young and those of the varied groups in their choice of service or activities, that brought about a great change in those experiences through that period in that land. The name then was Ar-Ar-Est-Erl.

Princess Ar-ar-pheth (Reading 1479-1): Before that we find the entity was in the Egyptian land. There we find the entity was among those peoples who came into the land; being an associate –yes, a sister– of the Young King that was put into power for the greater activities.

The entity joined in the activities when the Priest was banished; the entity joined *more* in the activities when the Priest's return made for the separations of individual activities. Hence the entity in that experience became a teacher, a judge –yes, as one who counseled with those in choosing what ye would call in the present as a life's work or activity. Then the name was Ar-Ar-Pheth.

Princess Ar-tek-la (Reading 2650-1): Before that the entity was in the Egyptian land, in those periods when turmoils and strifes arose because of the judgments of those in authority upon the Priest, –during the periods of rebellion that arose with the banishment of the Priest. The entity then was in the household of the King, and a sister of the Young King appointed to meet or to measure with the problems in the land.

Then the entity was haughty, yet later *very*, very great in its abilities to *unify* those activities of the common people, as well as those of the Natives, and also those who became sojourners there from other lands –as had been the entity. Thus the entity was the little leaven that began to level the turmoils in that experience. There ye learned patience. In other sojourns ye forgot. Here, in this present experience, again learn patience, as well as hope and faith. For these are the basis upon which the really, truly spiritual, mental and material life may be builded. The name then was Ar-Tek-La.

Prince Usisso (Reading 760-4): In the one before this, we find in the Egyptian forces, when the greater laws were being given, and during the reign of the second of that rule, wherein the greater civilization of earth's people were being exhibited and the first temples being built.

The entity then in that of Usisso, and in the Temple worship, for the entity then the daughter of the first King of that rule, a brother being the ruler [341, Araaraart] who gave the greater rule to the peoples. The entity then giving much to the people, and the desire to preserve relics, old and new, of the desire to preserve the best for the worship of every nature, whether in family, friendship, or in the higher oracles, giving of the best; yet ever afar in some manners from a show of ecclesiastical worship.

Prince (?) (Reading 169-1): In the one before this we find in that period when there was the reconstruction of the division in the land now known as Egypt. The entity then was among those that came in from the north country, and was the younger son of the king who set up the new rule in the land, bringing much to the peoples in gaining the understanding of that taught by those that were put in power, and by the division the entity then *gained* much in the way of being able to discuss or to understand many sides of a question. This is an urge in the present, as the desire to know more.

Mother Superior (Reading 2670-1): In the one before this we find in that land known now as the Egyptian, in that period when there were many dissensions, many upheavals, through the activity of individuals in this particular period. We find the entity acting in the capacity of the Mother Superior, as would be termed in the present, to those in the temple. Here, many were the discordant conditions that arose from the sides that were taken by individuals, groups –in both sexes; for in *this* period, men –as well as women– came to counsel with the Mother.

Those of the period whom the entity contacts will be very decided in their opinions, or their likes and dislikes –as will the entity to those whom it contacts, for the entity forsook not its position throughout its whole experience; for being of those who were placed in this position by the activities of the priest and of the king who counseled or guided the young king in these various times, the entity gained through the experience; yet suffering much in the discontent that was experienced by the entity during the period over the troublesome conditions in the lives of individuals whom the entity thought much of, whom the entity claimed as its own; for many sought the counsel.



Princess Ar-ar-sas (Reading 1500-3): Before that we find the entity was in the Egyptian land. There the entity was a princess –a daughter of the young King that had been raised to authority. And, as would be called in the present, the entity –owing to the position and the activities, and the things roundabout– became rather impudent, rather overbearing; until, in the latter portion of its activity, there came the closer associations with and the greater comprehending of the spiritual purposes.

Because of the very needs of the body, the very needs of the activities, the entity became closely associated with those who dispensed the things that were for the healing of the body; who prepared those things from the mineral as well as the vegetable kingdom for their influence and application not only as food but as medicinal properties in the experiences of others. Then we find that the entity, Ar-Ar-Sas, became rather as one whom many doubted, yet one whom many called blessed.

Princess Ar-r-kedeuveo (Reading 1532-1): Before that we find the entity was in the land now known as or called the Egyptian land, during that period when there were turmoils and strifes among those peoples, when the priest was banished. The entity then was among the children that were of the household of the King –the Young King; close in association and activity with those that made for the banishment of the Priest...

The entity was known as a princess, but among those that were to choose rather the activities in and about the Temple of Sacrifice when there had been the return of the Priest and the renewing of the activities among the natives, the Atlanteans, and the Priest and the peoples that came from the Abyssinian land. In the experience the entity gained. For the entity grew to be one upon whom many of those in the service of the Temple of Sacrifice depended; owing to the many changes wrought there by the entity –in the name then Ar-r-kedeuveo.

Princess Ar-teshet (Reading 1469-1): Before that, we come to the one that may be said to overshadow all the others. For there the entity was the Princess, or the daughter of the Young King in Egypt when all the turmoils and strifes arose; and when there were those activities that made for the influences which changed as it were the whole conditions of the world –or the Earth– in the experience. And there the entity may be said to have been as that influence which turned same. For not only from the counsel of the Counselor was the Priest banished but by the word of the entity at that period.

Not only was the Priest recalled by the supplications from without, and the activities by those of the King's own household and the Rebellions and the declamations by those from the Atlantean land, but because the entity had come to the experience and to the consciousness that such must be; not only for the material gains but for the satisfying of that within self that had become so much in turmoil, through the strifes that had arisen in the entity's father's own household.

Then with the reestablishing of the Priest, the entity became active in not only the religious services but the varied forms of expression in the hospitalizations, in the teachings, in the active service in the training of all classes and activities. For the entity then carried on much of that which became the active service.

Princess Issississo (Reading 2717-1): In the one before this we find in the Egyptian forces, when the first laws of the religious communication and rule were being made as mandates for man. In the second ruler of that day [See 341-10, Par. 4-A on 6/2/25], we find the entity then in that of Issississo, and in this time and period the entity assisted much in the correlation of the data in the manner and way of the scribe to the entity who gave the laws regarding such conditions.

Princess (?) (Readings 2725-1, 341-10): In the one before this we find in the country when the first laws of the rule were given, in now the Egyptian country. The entity then in that of the small child, or offspring from the ruler of that land, only remaining in the Earth plane a very short while, yet gaining through this entrance the desire of the self rule... and the one close to the King in this period, of the favorites.

Ax-tell (Ajax) of Ode (Reading 487-4): In the one before this we find in the land of the Poseidians when the rule was in the house of Ode, and the entity then gave to that people the manner of use of the universal forces as may be applied in the way of mechanical construction in a physical plane. The entity then known as Ode.

In this we find in the present plane that ability to grasp easily, quickly, every condition as is presented to the body, yet this, as we see, depending upon the manner in which the developments may be made in present plane by those having the charge or direction of the entity in its gaining the first principles of applying the urge as comes to the developing of the mental abilities, with the position in which the physical finds itself in the present sphere...

But this entity, entering under such auspices or conditions [at birth], brought [an intense lightning storm] with same –as we have indicated from the sojourn in the Uranian influences– that which might make for soul development or soul retardment, by its activity or by its application of the laws that are universal –or from the God-Consciousness in the realm of activity. For, ... oft *has* it been seen in the activity of the entity thus far, even in the material things and material associations –*many* have blessed the coming and many have been glad when the entity has passed from, or body has passed from, that environ or that experience.

Hence the entity or soul here wields in the Earth in the present a place of *power* –yea, more than power. One that may be made into those things that may be beautiful, if they are enjoined with the love that is seen in the Creative Forces activated by the Christ Consciousness, or made in such measures that there may be warnings to many that though they gain the whole world and lose their own soul what has been gained?

From an experience, then, in the present there are the activities mentally that must be weighed in the balance; and if they are found wanting in the associations of the entity in the material things, in the mental things, woe be to many! Yet the entity has arrived at that place in this experience in the Earth when it must choose for itself...

For, if the purposes, the desires, the aims, do not take hold upon something far beyond those things that partake of the Earth-Earthy, then indeed does the soul become impoverished and the time and space grow weary –and those things that make for turmoils and strife, that make the heart and soul weary, come into the experience of all. But if the heart and mind forgive those who despitefully use them, those that speak evil in divers places, those that find fault with others will find fault in themselves; for they are writing their own record –they must meet, every one, that which they have said about another; for so is the image, the soul of the Creator in each body, and when ye speak evil of or unkindly to thy brother, thou hast done it unto thy God.

The entity came from the Atlantean land into Egypt when there were those periods of reconstruction in the land, and from those turmoils and strifes there arose much that made for individual and group development –and the attempt of those in the experience to foster or disseminate same; those things that were good.

The entity came then, in the name Ax-tell [of the House of Ode], from those forces that were in charge of the Law of the One.

In establishing self in that land, the entity found little of help; finding fault with the king in power, finding little in common with the priest that led; finding those things that measured not to that standard the entity had had in the land, withdrew on account of the associations –specifically– of the priest with those women, or those of the opposite sex in the land.

Hence builded in self much that must be met, must be counted, must be countenanced in the present experience –if there will be gained that which will make for the soul development. For, if there is not love such as in showing not only tolerance but patience and brotherly love and kindness and such, there may not be those expansions in any experience that will bring contentment.

Prince Ax-ituel of Ode (Reading 640-1): Before that we find the entity was in that land now known as the Atlantean, during those periods when there were the breaking ups of that land, when there were the wavings of the eternal laws of the One with those that worshiped Belial, those that worshipped the satisfying of physical desire, those that worshipped ease and pleasure in the material world.

The entity then was among the priests of the Law of One, that pitted self against many of those things that were presented by a people that were being drawn gradually into self-indulgences.

In the experience the entity, in the name Axituel, suffered in body and mind, yet brought much strength, power and might to the followers of the presentations from the universal forces to the activities in that land; joining self, in the latter portion of its sojourn in the Earth, to those that went to the Egyptian land for the aiding of preserving the records of those lands that had become as abominations unto the Earth; for being so outnumbered in might of main or of carnal forces they brought destructive forces upon themselves. The entity aided in helping those that had given of themselves; losing the life soon after entering into the land, but laying it aside of his own.

Prince Ax-tenuel of Ode (Reading 1135-1): Before that we find the period which makes for the greater activities in the present experience. It was during the egress of those peoples from the Atlantean land (now known) who settled and became active in the Egyptian land. There the entity made for the greater progress in its development from the mental or soul experiences, in that particular period.



For with the return of the Priest, with the gatherings of the various understandings or teachings, the entity then made a study of such; and classified and interpreted same for the many, so that *application* of same might be made in the experiences of those in the Egyptian land as well as in the Indian, the Mongoloid or Mongolian or Gobi, the Carpathian, and the Og, and those lands across the seas in those experiences.

Then the entity, in the name Ax-Tenuel, was a close friend of Ax-Tell [487, Nikola Tesla] –that made for those developments in the chemical and electrical appliances in the experience.

Prince Ax-ten-tel of Ode (Reading 1150-1): Before that we find the entity was in the land now known as or called the Egyptian, during those periods when there were the establishing of those associations from the Atlantean land, from the land of Saneid and from Og.

The entity then was among the leaders and emissaries, and was an emissary to the Carpathian land; being of those peoples from the Atlantean land. And with the training and the tenets of the Law of One, those things pertaining to that which first brought the conveniences in the lives of those that were home builders, and then those things that made for the establishing and acknowledging of the relationships of the individuals to their fellow man and to the Creative Forces –the entity established same in that land which later from its teachings founded what is known as the Grecian regime. In the experience the entity gained, in the name Ax-Ten-Tel.

Prince Ax-ten-tna of Ode (Reading 1486-1): Before that we find the entity was in the Atlantean land, during those periods when there was the knowledge –through the teachers or leaders in the Law of One– as related to the destruction of the Atlantean or Poseidon land.

And the entity was among those who journeyed from Atlantis or Poseidia itself, first to the Pyrenees or Portuguese land and later into what would be called in the present the Egyptian land –during those periods after the recall of Ra-Ta, when he with Saneid and the activities from the land of On and Oz and those from what is now known as the Gobi land attempted to make for a unification of the knowledge.

Hence we find the entity then, Ax-Ten-Tna, as would be said in the present, was the first to set the records that are yet to be discovered, or yet to be had of those activities in the Atlantean land, and for the preservation of the data, that as yet to be found from the chambers of the way between the sphinx and the pyramid of records.

Prince Ax-ten-elo of Ode (Reading 619-5): Before that we find the entity was in that now known as the Egyptian land, during those periods when there were the incomings of those from the Atlantean land.

The entity then was the brother of Ax-Tell, that became active in attempting to unify the purposes of Ra-Ta with the Atlanteans –and aided in establishing, after there had been the rebellions and the reestablishing of the King and Ra-Ta's activities, the greater expression in *all* lands pertaining to the jewels and those things pertaining to the Temple Beautiful in its activities –among the daughters of the land and the peoples that dedicated or made for concentration or consecration of themselves and their bodies for the activities. In *these* did the entity then, as Ax-Ten-Elo, make the greater expressions in material things.

Prince Ax-el-tan of Ode (Reading 1066-1): Before that we find the entity was in the Atlantean land, during those periods when there were those activities that brought destruction upon the land –by those who had turned, did turn, the advanced activities into destructive forces.

The entity was among the children of the Law of One; those that were the sons of men, yet of the daughters of the Lord or those who had become purified of those entanglements in the animal forces that became manifest among many. Then in its activity, as Ax-El-Tan, the entity made those attempts to curb the activities of the sons of Belial and Beelzebub. [Beelzebub - Mat. 10:25, etc.]

Hence it rose to those positions as the warrior among the Atlanteans; and turned to the use of destructive forces with that expression which finds itself in the entity's activity in dealing with things to 'fight the devil with his own fire.' These became the law of the entity.

Yet when these things arose more and more to the force of the Law of One, from the spiritual import, they made for the turning to those things that we know in the present as *conveniences* for man.

Prince Ax-exten of Ode (Reading 2697-1): Before that the entity was in the Egyptian land, when there were those reestablishings of the Priest and the coordinating of those activities from the Atlantean land, as well as the consideration given the Natives of the land.

The entity was one set in authority by the peoples from Atlantis, as a descendant of the Atlanteans, to aid in establishing a means of exchange between varied groups of varied lands. Thus there was the establishing or the bringing about of better relationships with those groups where there were the attempts to dispense or establish the tenets or truths which has been acclaimed or acted upon in that land. The entity was thus acquainted with those groups in the land of Said as well as Mu, and in On and Og. The name then was Ax-Exten.

Prince Ax-eltio of Ode (Reading 1731-1): Before that we find the entity was in the land now known as the Egyptian, during those periods following the turmoils and the strifes, when there were the beginnings of the settlements through activities not only of the Atlanteans but through the acceding of the Natives. For the entity was of those groups that joined with the activities of the Native who caused uprising in a portion of that land.

The entity then chose rather to be what would be termed in the present the historian, or the keeper of the records of the varied individuals in their respective activities as were chosen by the peoples of that period. It was when there was the bringing about of what may be termed tradesmen for varied activities, whether teachers, ministers, lawyers, doctors or *any* and *all* of such. The entity rather insisted upon the records for the advancement and development, in the name Ax-Eltio.

Prince Ax-elton of Ode (Reading 1423-1): Before that we find the entity was in the Atlantean land, just previous to the destructive forces being applied by the Sons of Belial –that brought forth the destructive influences.

The entity was among the children of the Law of One, and high in authority –or what would be termed in the present as the leader of the soldiery forces, or the law enforcement groups... Then the entity was in the name Ax-Elton.

Ax-jetelame of Ode (Reading 1094-1): Before that we find the entity was in the Atlantean land, during those periods when there was the second egress from the land owing to the destructive forces that had begun to become active. The entity was not of the ruler class, neither was it of what might be termed the peasant or the working class, but rather was it among the instructors in the activities in the land.

The sojourn from same brought the entity into that now known as the Yucatan land. And in those activities there did the entity gain much in the making for the establishing of the temple worship, the temple service, the temple activity... Hold fast to that thou didst gain in those experiences, as Ax-Jetelame!

Prince Ax-tutum of Ode (Reading 1003-2): Before that we find, that has made, will make in the present, great influences upon the entity's innate and active forces, we find the entity was in the Atlantean period.

And there may be seen even in the present, by those periods when associates may call the entity moody, when the entity finds that it must be alone and think things through for itself, that arise from those experiences of the entity in the Atlantean land, when the entity made those choices for the Sons of the Law of One, and when the entity had to make those choices for that as was to deal with those who brought destruction by the misapplication of spiritual laws in material ways and manners. The entity then was in the name Ax-Tutum.

Prince Ax-ped of Ode (Reading 2284-1): Before that the entity was in the Egyptian land, during those periods when there were the activities from those peoples who entered from the Atlantean land... for he was of those of that land who had gotten many of those purposes of the sons of Belial.

Thus the entity caused upheavals and disturbances through the early portion of its activity; yet in the latter portion there were those things that brought about a helpfulness to the many –in aiding individuals to find themselves and to *insure* themselves, as it were, against the activities by certain groups. For, the entity warned of those who were in positions in which there might be the political affairs or activities of some groups to affect them. The name then was Ax-Ped.

Priest Ax-abs of Ode (Reading 2246-1): Before that the entity was in the Atlantean land, during those periods of the greater expansion, the periods when there were the attempts to *unify* activities –by the children of the Law of One. For, the entity then was a priest that ministered to the physical needs of the peoples.

Thus those who were in that stage of development or awareness in which their minds and bodies only worked for others, or performed the manual activities, were of special interest to the entity; in attempting to use the spiritual forces to *awaken* the consciousness of those individuals to the point that they could raise themselves from those positions to that of greater relationship with the universal consciousness. There again we find the activities in which disputations arose between the sons of Belial and the entity, –as Ax-Abs.

Princess Issua of Ode (Reading 845-1): Before that we find the entity was in that known as the Atlantean land, during those periods when there were the preparations for those that were of the household of faith, or the Law of One, when there was seen that there were to become the destructive influences that must shatter, must destroy the land, the peoples.

The entity was among those that were to become the emissaries or the sojourners in what is now the Incal land, or the Peruvian land. Later from that sojourn the entity came to what is now the Central American land, aiding in the establishing of not only the tenets but the manners and the forms of worship during those sojourns. The entity was among the princesses of the land, not only of the Atlantean but of the Ohum and Og lands –and later Muri [Lemuria].

In the experience the entity gained throughout, in that it adhered to the Law of One; that there must be the application within self, the same application to the fellow man –for that which is the motivative force in each is of the same source, or one, and brings the ability in associations for the increase to come from constructive or the God-forces in the associations.

Then, as to the abilities of the entity in the present and that to which it may attain, and how: First, look within self. Know as to what is the motivative influence within self as to the satisfying of self's own desires, as to that which would maintain the Law of One, of truth, of self within self; or is it –the motivative influence avarice, greed, or that which is of self's own desires?

Then know that the motivative forces and influences are founded in that set as the Princess of Ohum [On, Ecuador] and Og [Peru], in the name then Issua; which brought that which saved the lands during those experiences.

They are not founded in truth unless of that oneness of purpose. This determined within self, then know that as ye apply that ye know day by day in thy activities with thy fellow man these make for contentments in no matter what state of mind or body self may be put; for there is that contentment in that the self is a channel of blessings to someone, not as of self but through the manifesting of the love of the Creative Forces as expressed in Him –as... thou knew from thine own personal activity in the Ohum and Og land.

Prince Ax-telus of Ode (Reading 2301-1): Before that the entity was in the Atlantean land, when there were the periods of the breaking up; when there were the activities necessitating those who were acquainted with what was coming to pass going to other lands. The entity was among those who came to the Egyptian land, of the children of the Law of One, –yet coveting the principles of the children of Belial; thus causing in part those disturbances which arose in the Egyptian period of the entity's activity there.

Hence with the associations of Ajax and Beziel and Anan, and others of that group who undertook to hold to those activities which arose by the banishment of the Priest, the entity was only brought to the better understanding with the return of the Priest, –through the aid from some of the Natives, and a few of the entity's own people. The name then was Ax-Telus, –or the son of Ax-Tell, the one who led in some of those experiences.

Princess Ax-elenta of Ode (Reading 2487-1): Before that the entity was in the Atlantean *and* the Egyptian land. For, the entity was among those who came into Egypt who were in authority in the Atlantean land; being among the children of the Law of One, and instrumental in influencing the peoples to the uprising –or to the attempt to take advantage of the situation when the Atlanteans came into Egypt. For, then –as called by her peoples– the entity was a princess, or a daughter of a ruler of the peoples in Atlantis. The name was Ax-el-en-ta.

Prince Ax-entol of Ode (Reading 1574-1): Before that we find the entity was in the Egyptian land, as now called. There the entity was among those who were the Atlanteans that came into Egypt. The entity was young in years when brought in, and of the household –and the son– of Ax-Tell; being of those Atlanteans who made for such great changes in the conditions and affairs and the peoples in the land.

Hence we find the entity then was a supervisor over the granaries, the storehouses of gold, the storehouses for the precious stones, the divisions of those things that were to go to those in power or authority for the sustaining of the land, and for the propagation and distribution of knowledge as might be of a helpful nature.

Then entity, then, was in the position of what would be called the engineer in the broader sense. Not only the engineer in being able to lay out the lands, the construction of bridges and viaducts and ships and things or activities that made for the preservation of same, but in the holy things - or in the building of the altars in the Temple of Sacrifice and in the Temple Beautiful. Then the name was Ax-Entol.



Princess Ax-tecl of Ode (Reading 945-1): Before that we find the entity was in that land now known as the Egyptian and the Atlantean experience... then in the Atlantean land when those were being chosen to carry the various forces and influences throughout the Earth's experience for the training or retaining of the activities.

The entity then was among those of the Law of One that went to what was then the Egyptian land, in the name Ax-tecl; in the same sex, yes; making for much that drew the beauty of expression, or the entity engaged in the activities particularly to express the beautiful through dress.

Princess As-ma of Ode (Reading 1986-1): Before that we find the entity was in the Egyptian land, during those experiences when there were those who journeyed there from the Atlantean land.

The entity was then among those of the younger ones (of its same sex as at present) who came into the Egyptian land; and hence while craving much of the experiences as a child in the Atlantean land, it knew little but turmoils and strifes during the Egyptian experience; yet growing into a power through the applications of self to the tenets indeed of the Law of One, –the children who understood that principle from the beginning, "With what measure ye mete, it is measured to thee again," or with what purpose ye seek do ye find the law of the Lord...

For they became the tenets of the teacher as he returned to the land, and these brought closer associations with the entity's activities, as the daughter then of Ax-Tell [487, Nikola Tesla] brought into the activity of the individuals in the service with Ra-Ta, created a union of the God-forces for activity in the material plane... For as indicated, ye held to thy purpose under stress and strain in the Egyptian land, as As-Ma...

Prince Ax-etz-en of Ode (Reading 3152-1): Before that the entity was in the Egyptian land during those periods when there was the spreading of the activities of the Priest who was called back into authority or place. Then the entity was an emissary; though taught in all the usages of chemical and electrical forces, in conjunction with the preparation of bodies for the propagation of the species in the Temple of Sacrifice.

Hence, we find the entity may prepare itself as a physician, *but especially* should this be in those activities directed toward electricity as combined with the chemistry of the body, and the usage of same in applying chemicals to the body through vibratorial methods. These would become those channels through which the greater expectations and greater activities may be a part of the entity's experience in this particular sojourn. The name then was Ax-etz-en.

Prince Ax-ten-tor of Ode (Reading 2542-1): Before that the entity was in the Egyptian land, during those periods when there were activities established for the propagation of truth and law and order; in which individuals were to be considered as a part of the welfare. The entity was of the Atlanteans born in the land, being then part Egyptian and part Atlantean. Thus we find the entity rising to authority in the tenets for the individuals that aided in establishing unity through the various groups, throughout the active forces in the world.

The entity was associated with all forms of communications, that will again be a part of the entity's present experience –as indicated in its seal– and yet dealing with all types, all characters of conditions in the varied lands... The name then was Ax-Ten-Tor.

Princess Tulu of Ode (Reading 1286-1): Before that we find the entity was in the land now known as the Inca or Peruvian or Ecuador land, during those periods when the people from On and Og were making for so many changes –by the disturbing forces which arose from individuals who came into the land from the Atlantean land, as well as those who were to journey for the establishing of activities in what is now the Yucatan land.

The entity then was a princess, and a daughter of one of the rulers [Ajax] associated with the one [470 Asphar, Thomas Townsend Brown] who with so many wives (of which the entity was one) made for both good and bad.

Hence the entity was given to the keeping in line with the activities of those who were to establish new outlying districts. Hence the beauty of the entity, as well as its associations of power and strength, made for those activities in the Yucatan land –with those of the Atlanteans as well as those from the land of Og and On– that brought about a great advancement.

Through those experiences the entity advanced far because of its abilities in judgement as drawn from nature, as well as from the signs of the heavens and those activities that same bear upon the influencing of man, –as well as the seasons and the crops and the like, that were a part of the dependence of each people during those periods. The entity gained throughout that experience, yet –with the regenerating, or the degrading as it became later, to those sacrifices that took hold of the offering of bodily forces, –these became a torment...

Thus does it behoove the entity to find in those activities that which will bring about in the experience that which will make *home* –as a *reality*; close to nature. Not in the strife and turmoil, not in cities, not where there are the surroundings of those forces that bespeak of the commercial life, but that as of *nature*!

That as was given by the entity then as the priestess of those peoples, that made for the dedicating of their lives, that which would bring into the experience of each soul its relationships to *nature* as it manifests itself in its defiance of, in its laws with, in its beauties of, in its troubles with humankind; as it meets same in the rain, the sun, the storm, the dew, the beauty of the sun and the moon and all the glories of nature itself become rather as the song of the entity in its experience; when the sons of God with the voices of the winds sang together of the heralding of the glory of the noonday to the sons of God! That became as the chant of the entity in that experience, in the name Tulu.

Prince Elmeur of Ode (Reading 876-1): Before that we find the entity was in that called the Atlantean land, in those periods when there were the beginnings of the activities of the sons of Belial and those of the Law of One.

The entity then was among those peoples that were of the Law of One, yet it was set upon because of being in the position of power –being the *son* of the ruler, or Ajax [487, Nikola Tesla] , and in the name then Elmeur.

The entity, as the Prince of the Poseidian land, was set upon by the sons of Belial to make for those activities that would bring the desecrating of the Temple of the Law of One; through those influences of the daughters of the sons of Belial.

Arda (Reading 2713-5): In the one before this we find in that period when the division arose in the land known as Egypt. The entity then the assistance to the priest that was banished, in that the entity was then the *mother* of the priest, and aided in the setting of the priest in the position to gain in power and position; being in years when the entity came into the land, yet many days were given in sorrow for the error and in supplication for the return and the building again of that as had been set by the alien, the native, and the friends of that period. Then in the name Arda.

Arhira (Reading 340-15): In the one then before this we find in that land now known as Egyptian land, and during that period when there were turmoils and strife through those conditions as arose from banishment of the priest.

The entity then of the household of the priest, being a sister; yet rebelling *against* the priest when banished, or taking sides rather with the king, in that this offered to the entity the easiest way out for the moment; and in this experience the entity lost *and* gained, and lost. Being in this position socially, politically, many were the favors that were shown *to* the entity, in the name Arhira.

In these favors shown, the entity took advantage of same in some manners; for when persecutions arose to the house, and the entity sided with those that made for the easier way with the rebellions that arose, then hardships came, and the entity sought to know more of those tenets that were brought by the priest.

Asua (Reading 369-3): In the one before this we find in that land when the divisions rose in the land. The entity then the lawful wife of the priest (Ra-Ta) who forsook those that had been set in the right way for those conditions set in the temple. The entity then in the name Asua.

Ra-la-ral (Reading 282-2): In the one before this we find in the land known as the Egyptian, and in that period when there were rebellions in the land. In this period the entity was among those who succeeded in the latter portion of that rule, for the entity –being in the household then of the priest– gained in power and in [its] use...

As the entity developed in body and mind, and as the powers were gradually shifted to the entity as the responsibility for the carrying on of the forces that were manifest, the entity gained through the experience; losing only in the latter portion when there again rose rebellions, when the entity pitted self against many who had gained power *from* the spread of those tenets given in the land; yet in this same tomb –in the upper portion of same– is the chamber there of Ra-La-Ral. In the leading of the people to the services of those before the beasts, the entity failed, for this brought in those of another people that led the peoples later astray.

Amarat (Reading 279-4): In the one then before this, we find in that land known as the Egyptian land, during those periods when there were those divisions in the land, and there were those expulsions of the priest [Ra-Ta] and of those that gave those understandings to the peoples. The entity then was the *son* of the priest who was in exile, returning to become a power in the developing of those influences that gave to the world, as well as to the land, the highest point of the civilization *in* that period, or for *any* period as yet.

The entity then, at the height or the power *of* that experience, stood in the place as of the Council, and as the ruler of that land; not as the king, but as the counselor *to* the king, and as the priest that took those influences of that *builded* and added the dispersing of that as had been gained.

Gaining throughout the experience, for under the guidance of the sire the entity in that land became as the one upon whom that priest leaned, and upon whom the *world* at large depended upon for the dispersing of that through those associations, those connections, that the entity –in the name Amarat, gave *to* the peoples at that period.

Ar-el-el (Reading 1709-3): Before that we find the entity was in the land now known as the Egyptian, during those activities of the rebuilding through the purposes of the Priest, as well as those who went about to restore order out of chaos through the rebellion forces of the Natives and those entering from the Atlantean land.

We find the entity was among the daughters of the Priest in that experience, in person, –being born of those peoples that were of the purer race for definite activities during the experience; and thus in the services or activities of the Temple of Sacrifice as well as the Temple Beautiful.

The entity acted rather in the capacity of one that would issue the edicts for the moving up, or the placing of individuals in those activities for special services through that experience. The name then was [named] Ar-el-el.

El-aradth (Reading 3098-2): Before that the entity was in the Egyptian land, when there were those preparations for individuals becoming active in the resuscitating of varied groups, those who were prepared as emissaries. The entity then was a daughter of the Priest who built up the activities there; being sent to the Chaldean land as an emissary. The name then was El-Aradth.

El-ar-ela (Reading 1857-2): Before that the entity was in the Egyptian land. The entity was the daughter of the Priest who caused the many changes to come about in the land; both in association with the Natives and those in authority from the various groups, especially those who had been in rebellion, the entity was able to bring more harmonious activity because of the close associations through the experience with the leaders of those rebellions.

Through these associations there were the abilities for the entity to aid in being very helpful when there was the dividing of the political and religious offices (as would be termed in the present). For the entity was in close association with those from Atlantis, as well as with the Young King, as well as with the native peoples...

Then the entity was in the name El (meaning beautiful) -Ar-Ela. In the experience the entity was held almost in as much reverence as the companion of the Priest, Isis [or Isris]; and many of the figures of the entity were a part of the hieroglyphics that later became a part of the worshipfulness of many of the peoples.

Because of the entity's close associations with those who were the animal worshippers, these brought discouraging and disconcerting activities, but they eventually came to be channels through which great help came to the peoples in that experience.

Ar-bab-lo (Reading 3652-1): Before that the entity was in the Egyptian land, when the daughters of the Priest and associates were being tempered in the Temple Beautiful and the Temple of Sacrifice; when individuals were prepared for activities which today would be termed diplomatic relationships, as emissaries and teachers in various lands.

The entity was among those groups who went into other lands. Thus the innate desire to know the mysteries underlying the promptings in the emotions of various groups who set about to teach that having to do with the mental, material or spiritual aspirations in the lives of individuals. The name then was Ar-bab-lo.

She-aar-el (Reading 1246-2): Before that, then, we find the entity was in the land now known as the Egyptian, during those periods when there were the preparations for the Temples of Sacrifice and the Temple Beautiful. There again the entity, as a daughter of the Priest Ra-Ta, made for the preparations for the Temple Service, or the temple furnishings. For these became as a part of the entity in that experience. In the name then She-Aar-El, or the 'daughter of the son.'

Sevrden (Reading 3234-1): Before that the entity was in the Egyptian land, during those periods when there were the preparations of individuals as a part of an experiment, as a part of the experience for those that would change in their form of activity to be more perfect in body.



The entity then, as a daughter of the Priest in those periods when there were greater activities of a spiritual nature, supplied the music that would span the distances between loneliness and crowds, that would make for the lifting of the soul in those periods even when operations were performed under the soothing strains of same. The entity perfected the stringed instruments. And when there was the roll of the organ in the ecstasies reached in the Temple Beautiful, again the entity supplied same... The name then was Sevrden.

Astra-al-on (Reading 5049-1): Before that we find the entity was in the Egyptian land, when there was the choosing of individuals as models through which the activity in the Temple Beautiful, as well as from the Temple of Sacrifice, was carried on.

The entity then, as a grand-daughter of the Priest, stood out as the model for those who were in activities in the various channels of home building, or preparation for modeling activity in other lands, in the name then of Astra-al-on.

Isis-bee (Reading 2464-1): Before that the entity was in the Egyptian land, during those periods in which there were the activities of reconstruction by the Priest, as well as those influences from the Atlanteans and the natives of the land.

The entity then was of the household of the priest; being then a granddaughter of the Priest; aiding in those activities in which –through the Temple of Sacrifice and the Temple Beautiful– there were choices made by individuals as to their service, –in what today would be called vocational guidance. Then the entity assisted individuals to make those choices... The name then was Isis-Bee.

Priest Rha-ha (Reading 228-2): In the one before this we find in the Egyptian forces, when the second king [341, Araaraart] ruled in that land, coming from the plains as the guard to the ruler and the courts, then giving the first laws to the people as regarding manner of life in Earth and that expectancy in death.

The entity then in the name of Rha-ha, and in that plane we find the entity developed to the position of taking the place of the deposed first high priest in that time, and gave much judiciary knowledge to that people. In the personality then shown in the present life, we find still that seeking of all forces pertaining to judiciary subjects, and especially as related to the physical, moral and spiritual life of individuals.

Arisis (Reading 2125-1): In the one then before this we find in that land now called the Egyptian land, and during that period when there was the sending away of the priest with the companion. The entity then the companion of the priest's companion, being in the position of the sister of, and a close friendship (which seldom is among those) in that period, going *with* the banished priest and companion, returning with and aiding in establishing the proper relationships of the priest's companion *to* those that had been raised to position and power when the dissemination began of the truths as were given out.

The entity then in the name Arisis. In this experience the entity gained and lost. *Gained* through the love influence as manifested, for the conscientious conditions as held, the conscientious activities as were manifested in the turmoils and strifes; though not *agreeing* always *with* the sister... yet the duty, the love, the beauty of the life of each, brought *that* association, bonds of sympathy *with* those in this experience. The entity gained in the giving of understandings to many that aided in the dissemination of the truths that were taught.

Priestess Isris (Reading 538-9): In the one before this we find in the Egyptian forces... the entity was of the household of the assistance [assistant priest Rhaha] to the one becoming the leader in the religious cult, Ra-Ta, and being of beautiful figure and form, and giving the condition to him who was the leader brought through her seductive forces much troubles to self and that entity.

This bringing banishment to the group brought distress and physical suffering to each, in that the entity set about to bring the enmity of many, and in the present we find grudges easily held and that the entity must overcome to reach the development that will bring the best, whether of mental, physical or spiritual forces. As to the name at that period, we find in Isris...

Isibio (Reading 301-1): In the one before this we find in that land now known as the Egyptian, and in that period when there was the re-establishing of those peoples from the turmoils and the strifes as had arisen from the banishment of the priest [Ra-Ta] in that period. The entity was among those of the temple worshippers, being then an offspring of the priest during the exile, and coming in the influences of the period the entity became one of the priestesses of the temple, *later* being that fair one that set up a temple in the [Libyan] land to which the priest *had* been banished. In the name [then,] Isibio.

Iso (Reading 288-1): In that before this we find in the lands just before the present plane, as given, in the Egyptian forces, and in the rule of [King Araaraart,] the second ruler of that land, when the glory of the country was near its height, and was in the household of Ra-Ta but the sojourn in that sphere was of short duration, for we find only a short span is given in Earth plane.

Aris-hobeth (Reading 2329-1): Before that the entity was in the Egyptian land during the period of turmoil and strife. The entity was among the daughters of the High Priest who was sent into exile; the entity then being very close to the Priest in those activities which brought about the banishment, encouraging the Priest in the associations with those individuals for which the King and the Counselors banished the Priest.

These brought turmoils for the entity, yet with the return of the Priest to authority, and the establishing of the Temple of Sacrifice and Temple Beautiful, the entity was active in both of these. Hence a judgement of individual characterization is a portion of the entity's experience in the present. The name then was Aris-Hobeth.

Is-ar-is (Reading 2572-1): Before that the entity was in the Egyptian land, among those of the household of the Priest and those in authority that became a part of the experience during the periods of reconstruction. The entity was the second of the offspring of the Priest and the companion for which it was banished.

Through the experience the entity kept close in associations with the King as well as the counselors. With the establishing of the Temple of Sacrifice and the Temple Beautiful, the entity chose of its own self to become one of those prepared by or through the ceremonies of each of these Temples for the activity of furthering those ideas and ideals which were a part of the experience through that particular period... The name then was Is-Ar-Is.

Is-tu-bu (Reading 951-4): Before that we find the entity was in the Egyptian land, during those periods when there were the turmoils and strifes which arose through those activities of the King and the Priest, and the banishment of the Priest. There we find the entity was among the daughters of the Priest in those periods when there was the return and the building up of those activities in which there was the establishing of the Temple of Sacrifice, the Temple Beautiful.

The entity was reared in that Temple Beautiful, for the preservation of those activities in which there was to be rather the pure strain of the pure blood. Thus the entity rose to one of power through those periods, until there was the uniting with that influence which arose from the Atlanteans that brought the children of Belial's seeking for self-indulgences. The name then was Is-Tu-Bu.

Isiso (Readings 136-1, 341-10): In the one before this we find in the Egyptian forces, and under the second King, we find the entity, in that entity then known as Isiso and in the Temple as one of the ones making music before the altar as erected there for the first times. The entity then received the greater development in the Earth's plane, and reached the understanding of occult and mystic forces... In the latter portion of this same period and in the house of the Priests and very close to the sage of that time, who then being up in years needed the attention of those who could bring help to same. [She was the] King's favorite at the same time.

Is-it-buel (Reading 1404-1): Before that we find the entity was in the Egyptian land, during those periods when there were the turmoils and the strifes between the Natives and the King, between those of the household of the King and those of the people entering from the Atlantean land.

But during those periods when there was the reestablishing of the Priest and those interpretations of many lands correlated, the entity then –as Is-It-Buel (as would be called in the present)– aided those not only in the Temple of Sacrifice but in the Temple Beautiful, and also in the hospitalizations and the interpretations of things in their mental relationships to those that had through sacrifice rid themselves of those things that were still as appendages, still those materializations of matter as associated with the physical body.

Is-it-ao (Reading 4227-1): Then we find in the plain country in the Egyptian forces. [See 341-10, Par. 15-A says that in the Ra-Ta period, her name was Isitao, in the household of the Priest, King Araaraart's favorite.]

Isisao (Reading 1100-1): In the one before this we find in the land of the now Egyptian forces, when the second ruler then in force was giving to the peoples and the world the first laws pertaining to the relation between Creator and created. The entity then in that of the scribe to the High Priest that assisted in giving these laws to the people, and was then the educated one that was taken as prisoner and made the scribe to the High Priest, for the abilities of the entity surpassed many of those in that country.

In that day the name was that of a two-fold, or coming from the country of the Arabians (now known) the entity known then as Aidol [See 341-9, Par. 18-A]. In the new position as occupied, the entity then given the name by the High Priest as of Isisao.

In this we find the entity gains the deep study and the deep import of the necessity of the entity studying and seeking out those inner laws pertaining to the relations of the past, present and future, that may be found within the study of self and the relations to others whom the entity may contact, knowing well that these are a part of each and every individual that gives study and thought to these to the extent of making them a portion of their inner selves, for the inner self being the real self and the manifestations from within those manifestations of that of the reality of the entity.

(?) Emissary (Reading 3635-1): Before that the entity was in the Egyptian land, when there were those activities in preparation of individuals and groups for dispersing the truths, or as emissaries and teachers, in which there were exchanges with other lands. The entity again was a daughter of the Priest in that experience, and was sent to be active in the Mongoloid or Gobi land.

(?) Queen of Persia (Reading 5125-1): Before that the entity was in the Egyptian land during those periods when there were the activities in the Temple of Sacrifice, as well as in the Temple Beautiful. There the entity was a daughter of the Priest and was set in those activities that brought the entity to the throne as a queen in Persia, or in those portions of Persia that had been the dwelling place of the Priest.

(?) (Reading 2459-1): Before that the entity was in the Egyptian land, during those periods of reconstruction there. The entity then was the younger of the daughters of the High Priest, Ra-Ta, as there were those periods when there had been the regeneration and the choices for channels for the new race.

To the peoples of that period the entity presented what was called the sine qua non for that development; the highest as attained through that experience. Yet the entity misused portions of that activity in such ways and manners as to cause a falling away from the mindfulness of preparations through the Temple of Sacrifice. For there was the tendency of the entity to overemphasize that activity in the Temple Beautiful, as to make it of little effect in the developing of those in the latter portion of that sojourn. The activities then were as the leader in the various forms of activity.

Each Life Reading given by the Sleeping Prophet Edgar Cayce for individuals incarnated during the Ra-Ta period, whether located in Egypt or in other regions of the world where Atlantean temple practices were conducted, contain precious information concerning this high-tech cultural period on Earth. While each of these Life Readings contains only a handful of paragraphs giving details of the incarnation of that entity, the sheer volume given by Cayce offer a great wealth of information concerning the genealogy of the merging of the Royal Atlantean House of Ode from Poseida with the Royal Persian House of King Arart at the Orion Pyramids ~30,000 years ago.

This highly detailed reference frame must be understood in the broader context of the Atlantean civilization as described by Cayce through three long periods, *each lasting tens of thousands of years and ending in catastrophic destructions directly brought about by the misapplication of spiritual laws*. Very little information is provided in the Cayce Life Readings regarding the first elevated phase of the Atlantean civilization that followed the explosive destruction of the planet Kaantek (also known as Malon) that formed the asteroid belt ~79,000 years ago, as referenced by other reliable sources.

Archeological and Akashic research by this author has identified the presence of subterranean complexes belonging to this time period, perhaps built at ~70,000bp, below the bedrock of present-day Toson Lake, Qinghai, China (37.153°N, 96.993°E) and Panther Beach, California, US (36.992°N, 122.168°W).

*Flowing rock formations at these sites are virtually identical, yet differ from local bedrock*. Baigong Cave entrance at Toson Lake, China is located 15.09% of Earth's mean circumference distance from the Great Pyramid, while Panther Beach, California, US is situated at 30.18%, –being precisely twice the distance as Baigong Cave, China. These resonant distances reflect Fibonacci order (overleaf). Despite being located on opposing sides of the planet, both Baigong Cave and Panther Beach Cave are closely geopositioned along 37° North latitude despite tectonic shifting over the span of time since their creation. All of these remarkable features of the sites confirm their alignment to the Great Pyramid –built at ~73,400bp marking the Prime Meridian of Magnetic Resonance on the planet.





Panther Beach, California  
36.992°N, 122.168°W



Panther Beach, California  
Plasma melt rock formation  
~70,000 years bp









Baigong Cave, Toson Lk  
Plasma melt rock formation  
37.153°N, 96.993°E





## Timeline of Atlantean Temple Construction

Years bp	Significant Events
~79,000 bp	Explosion of Kaantek/Malon forms asteroid belt
~73,400 bp	Construction of Orion Pyramids by King Saluk
~73,333 bp	Brown Dwarf periapsis & Oort comet impacts
~72,000 bp	Construction of Atlan Pyramid, Blake Esc., FL
~67,000 bp	Construction of complex at Toson Lake, China
~67,000 bp	Construction of complex at Panther Beach, CA
~51,000 bp	Fracturing of Atlantis by subterranean explosions
~36,666 bp	Brown Dwarf periapsis & Oort comet impacts
~34,500 bp	Construction of Visoko Pyramids & Ravne Labyr.
~33,000 bp	Construction of Ohum walls and bands of pits
~30,030 bp	Great Flood cataclysm, Noah's Ark deposited
~30,010 bp	Reconstruction of Orion Pyramids by King Arart
~29,950 bp	Reconstruction of Poseida City by Ajax of Ode
~29,950 bp	Construction of Ohum Pyramids of On, Ecuador
~29,900 bp	Construction of Tayos Cave system, On, Ecuador
~29,900 bp	Construction of Samayreni complex, Og, Peru
~29,900 bp	Construction of Manco Pata complex, Og, Peru
~29,900 bp	Construction of Guanahacabibes Pyramids, Yuk
~29,850 bp	Construction of Azores Pyramid & city complex
~29,800 bp	Construction of Baltic Sea Monument complex
~29,800 bp	Construction of Llanganates Pyramids, On, Ecu
~29,750 bp	Construction of El Transito complex, Nicaragua
~29,750 bp	Construction of Altavista complex, Yuk, Mexico
~29,600 bp	Construction of Padang Pyramid, Indonesia
~28,000 bp	Construction of Yonaguni City complex, Japan
~27,000 bp	Construction of Gobustan complex, Azerbaijan
~25,000 bp	Construction of Saqsaywaman Temple, Og, Peru
~25,000 bp	Construction of Samaipata Temple, Og, Bolivia
~23,000 bp	Over-building of the Padang Pyramid, Indonesia
~23,000 bp	Construction of Nan Madol complex, Micronesia
~17,000 bp	Construction of Gobekli Tepe complex, Turkey
~17,000 bp	Construction of Menorca Temple complex, Spain
~15,000 bp	Construction of the Johnson Cave system, UT
~14,000 bp	Construction of Machu Picchu Temple, Og, Peru
~13,300 bp	Ohum World Map Stone, psychoacoustic whistles
~12,890 bp	Cometary destruction of Atlantis by Mu scientists
~10,000 bp	Construction of Puma Punku Temple, Og, Bolivia
~10,000 bp	Construction of White City complex, Honduras
~8,000 bp	Construction of Stonehenge Temple, England
~6,000 bp	Construction of Tiwanaku complex, Og, Bolivia
~3,000 bp	Construction of the Nazca Lines, Og, Peru

<u>Timeline of Atlanteans in Egypt ~30,000 bp</u>	
Years bp	Significant Events
~30,053 bp	Birth of Ra-Ta in Carpathian mtns region
~30,051 bp	Birth of Ajax (Ax-Tell) of Ode in Poseida
~30,035 bp	Mass evacuations of Atlantean lands
~30,030 bp	Great Flood cataclysm, Noah's Ark
~30,025 bp	King Arart invades lands of Egypt
~30,025 bp	Ra-Ta assembly of 44 at Orion temples
~30,024 bp	Birth of Araaraart in the Temple Beautiful
~30,022 bp	Birth of Ralij in the Temple Beautiful
~30,010 bp	Rebellion of native Egyptian population
~30,008 bp	Abdication of King Arart to Araaraart
~30,007 bp	Opening of Ophir mining operations
~30,007 bp	Birth of Aeoraen in Temple Beautiful
~30,006 bp	Birth of Azorut in Temple Beautiful
~30,003 bp	Birth of Issississo in Temple Beautiful
~29,996 bp	Temple reconstruction period completed
~29,995 bp	King Araaraart gathers inner council
~29,995 bp	Political Marriage of Ax-Tell & Aeoraen
~29,993 bp	Birth of Issua of Ode in Temple Beautiful
~29,991 bp	Political seduction of Ra-Ta by Isris
~29,990 bp	Banishment of Ra-Ta, Isris, etc.
~29,989 bp	Influx of Atlanteans into Egypt
~29,988 bp	Death of Iso, child of Ra-Ta and Isris
~29,982 bp	Dissention of Ax-Tell of Ode
~29,981 bp	Return of Ra-Ta, Isris, etc. to Egypt
~29,979 bp	Death of Ishuma of Ode in Poseida
~29,977 bp	Period of correlation of knowledge begins
~29,970 bp	Emissaries from Egypt sent to all regions
~29,968 bp	Princess Issua of Ode sent to On, Og
~29,911 bp	Abdication of King Araaraart to Azorut
~29,826 bp	End of temple service of Priest Ra-Ta
~29,814 bp	Death of High Priest Ra-Ta in Egypt
~29,806 bp	Death of Ajax (Ax-Tell) of Ode in Poseida

Based on a Great Flood date of 30,030bp according to the dating of shoreline materials (Lambeck, 2014), a detailed timeline has been established concerning the Atlantean influx into Egypt (above). This chronology outlines the high period of advanced technological activity at the Orion Pyramids, of present-day Giza, Egypt, that facilitated global cultural unification under the Atlantean tenets of the Law of One.

Participants from all civilized regions of the world made pilgrimages to Egypt for regeneration periods within the temple chambers, for both physical healing rejuvenation as well as genetic purification. The purpose of the advanced surgical and genetic healing practices accomplished in the Temple of Sacrifice involved removal of animal influences from the physical bodies of human beings.

Willing subjects were genetically purified *after undergoing extended periods of education and medical treatment, including regeneration periods in HHO plasma chambers*. Not only were physical and genetic problems healed, but the life expectancy of individuals who completed the process was effectively doubled in duration. Cellular rejuvenation of the physical body brings about a purification of mental strength, attitude and spirit-related consciousness through having received the Creator's gifts.

Contentions that arose during the exile of Ra-Ta between those genetically pure and the 'Things' were mentioned in a brief statement given during a Life Reading for a writer on November 16, 1939:

Oelom (Reading 849-45): Then, in those periods when there was the entering of the Atlanteans, with those 'Things' or servants, and the attempts of the leaders there to classify many of the Natives with such groups as had been brought in by the King, the Priest and the Atlanteans, there came consternation in the experience of the entity Oelom.

After entering the Egyptian lands with servant Things and using them as an underclass for many years, the Priest Ra-Ta reversed his ethical position on the matter by acknowledging the great need for mass cleansing services in the Temple of Sacrifice, and recognizing the opportunity for change in all humans:

Auoir (Readings 281-1,44): The one before this we find was in that land now called the Atlantean, in Poseidia. The entity was among those of the upper classes who belittled self that there might become a better understanding between those that ruled in power, might and mind, and those that supplied the necessity for bodily adornments or material supplies... The name then, as would be sounded in the present, was Auoir.

*Q: What was the character of the Atlantean teachings, that the Priest was called back to counteract?*

A: That all those who were without sufficient of the purposes to seek the whole light, because of the very influence of the appendages and [unwanted genetic] conditions which had been manifested in materiality such as to make them 'Things', were to be kept submerged to be used by those of the greater abilities.

The Priest held that these were one, and that such [unwanted genetic] conditions offered the possibilities through which each soul might find a way of escape, –by and through the purifying of the body in each experience, that the activities of same –in its passage through the various experiences necessary– might eventually become channels through which blessings, and knowledge of the divine influence and force, might be made manifest.

Technological inventions of Ajax the Atlantean leader from Poseida, engineered by Asphar, who had entered Egypt from the Persian lands as the armor-bearer of King Arart, where he had been called Osio. After technical instruction from Ajax (Ax-Tell, father of his wife, Tulu) Asphar participated in the engineering of bioelectrical healing devices employed within the temples for electro-surgical and HHO plasma healing for the removal of deformed body parts and spirit possessions:

Asphar (Readings 470-22,33): When in the Atlantean land, there were those making for that change that was for the preservation of the peoples; and the entity –with others– migrated to what is known as the Peruvian, or later known as the Incal land.

There we find the application of the electrical forces and influences was especially in the association and the activities of same upon metals; not only as to their location but as to the manner of the activity of same as related to the refining of some, and the discovery of others, and the use of the various forms or transportation of same –or transformation of same to and through those influences in the experience.

We find the entity there made use of the metal known as iron, or the combinations of iron and copper –which have long since been removed from use in the present; or copper so tempered by the use of same with a little of the iron, or in its formation in such a way and manner as to be hardened to the abilities for same to be used much in the way that many of those combinations have been found in the Egyptian, the Peruvian and portions of the Chaldean lands –and *more* will be found in the Indo-China city yet to be uncovered...



In the activities the application of these was in a little different order, of course, from that in the present. For the characters of the dynamo or the generators for same were used in a way and manner in which there was the transformation of the direct to the activities for using same much in the same manner (the entity will understand, in the study of same) in which gases are now used as a means for propelling force or influence to act as a pump for the transformation of casing-head gas to gasoline, and the *refuse* used to produce or make the power for the machine producing same.

That is, from the direct current passing through the activity of the fusing of metals and the transmutation that forms from same, and the active forces as turned into that in which it makes for the clearing of the refuse forces of the ore in such a manner that the very fuse itself becomes the source of an alternating current to which there is added then a stepped-up activity in which the direct current then becomes the source of the energy to produce this fusing of the metals or ores.

Again we find in the activities of same the entity made a soon return to the Egyptian land, when the entity made preparations for a part of the armor, or part of the defense; as the armor bearer or the protector for the activities of the King.

All of these activities then became a part of the use of electrical forces for metals and their activity upon same to be used as carbonizing them, or directing them in manners in which they became as magnetic forces for the applications to portions of the body for transmuting or changing the *effect* of activities upon the physical energies and forces of the body; able to use same as re-ionizing or re-generating the bodily forces themselves.

For as the very forces of the bodily functionings are electrical in their activity, the very action of assimilation and distribution of assimilated forces is in the physical body an active force of the very *low* [frequency] yet very high [amplitude] *vibratory* forces themselves.

Hence there the entity made application in those directions; and these act upon the influences or forces or metals, or active principles within the human forces themselves. For within the human body –living, not dead– *living* human forces –we find every element, every gas, every mineral, every influence that is outside of the organism itself. For indeed it is one with the whole. For it is not only a portion of, and equal to, and able to overcome or meet every influence within, but there is not the ability in the third dimensional force or influence to even imagine anything that isn't a part of the activity of a physical *living* organism! ...

Hence the use of these was a portion of the entity's experience, when there was the preparation for the cleansing and the transmuting of the bodies in the preparations for the new race. Those activities made for closer associations, for then Ajax –or Nikola Tesla [the present incarnation]– and the entity now called Thomas Townsend Brown made the application or use of the abilities in engineering, and the building of machines for the application of these to the bodies of individuals –where there were appurtenances to be left off, where there was blood to be changed, or where the vibratory forces were to be set so as to remove those influences of possessions; and where there were those activities in which with the combination of sodas the bodily forces were enabled to reproduce in a manner as cross to that to which it had been set in its natural forces...

During that era when the Second or Young King was put in authority, as one pitted against or to bring about the cooperation with some of the Natives and their activities, –the entity then was among those who had come from the Persian or Caucasian land, being an armor bearer or a personal guard to the King.

When those disputations arose among the advisors to the King, over those conditions arising with the Priest and those of that group, the entity still remained as one loyal to the King; not only then the personal guard but the friend and associate and advisor to the King; being near of the same age and of the same group or family.

During the period of the Priest's exile, there came into Egypt those from the Atlantean land, –among them Ax-Tell [Nikola Tesla], –who became close to the entity, –then the entity being in the name Asphar.

Being interested in every form of activity that might bring better conditions for individuals or groups, the entity was interested in those tales or experiences told by Ax-Tell; and sought demonstrations and experimentations with those influences which had been a part of the experience of the Atlanteans that brought about destructive influences.

With the return of the Priest to better establish a coordinant, united force or effort on the part of those of the King's household as well as those who had led in the various rebellions among the Natives, as well as the rebellion in Ibex of the King's household, –there came periods of a great deal of mental disturbance to many.

But during that period a great deal of the time of Asphar and Ajax-ol was devoted to the use of the electrical forces maintained from the use of static forces, as called today. And in their attempts to demonstrate or use these influences for a helpfulness rather than as they had been used upon nature or individuals, or those activities of a destructive nature, these were turned to minerals.

Thus the conditions in which there were the abilities for the fusion of copper and brass with the alloy that comes from gold impregnated with arsenic, with the casting of electrical forces through same. This brought those abilities of sharpening or using such metals as these for cutting instruments.

Also there were those activities and abilities of the entity to use the electrical devices as prepared through those periods of their investigation, for operative measures; wherein the electrical knife was in such a shape, with the use of the metals, as to be used as the means for bloodless surgery, as would be termed today, –by the very staying forces used which formed coagulating forces in bodies where larger arteries or veins were to be entered or cut.

Then, such were the greater activities of the entity through those influences which had to do especially with the Temple of Sacrifice. *There* the entity became acquainted with the offspring of the Priest, and thus there was the beginning of those activities which are as *yet* a part of the experience of each.

In making practical application of those forces in the present, then, –it will necessarily be through experimentation, of passing the powerful currents of electrical forces through the ores, the metals and those combinations of same in which there may be seen the uses of metals in forms as indicated, –that were *only* used through the experience and the experimentation of the entity as helpful forces during the reconstruction period in Egypt.

The entity then grew to be one who prompted the greater development along those lines, yet sought in a manner to preserve to self the purely technical manner in which those operations were cast. Thus much of that ability was lost after that period, and after the passing of those who labored or worked with the entity...

*Q: Considering the work in Egypt with electrical forces, explain just how I should apply those talents now.*

A: As indicated. In conducting experimentations, by passing a great current through certain compounds or mixtures of metals, that would produce –in smelting– a different metal. The combinations of iron, copper, of course impregnated with the various forms, which heretofore and in the present have been unable to be used in the forms of smelting that are the experience of man today.

*Q: Describe in detail the construction and purpose of the more important machines used by me then.*

A: As indicated, the machine in which there was the combining of metals in those periods of fusing or smelting, –that combined them in such ways that they might be used in forms not used today. Especially the use of electrical forces with the character of instruments in operations, as well as the fusion of such metals indicated.

*Q: What specific experimental work should be done now that would lead to an awakening of that ability manifested in the Egyptian period?*

A: The combining of the metals in their crude state by the passing of current in the various forms through same, during the period of smelting same, see?

*Q: Was Ajax, with whom I was closely associated in engineering, the same as Ax-Tell? Please explain the reference to him as Ajax in my Reading, and as Ax-Tell in other Readings. [GD's note: Now Mr. Nikola Tesla.]*

A: Called Ajax in the Atlantean land, being of the Atlanteans, and Ax-Tell in the Egyptian activity. One and the same. Ajax-ol was a different individual, see? [GD's note: Now Mr. Henry Ford.]

The breadth of highly advanced scientific details of Atlantean bioelectrical healing techniques given by the Source through the trance medium is astonishing. The basic explanation offered concerning electrically-induced atomic transmutation of metals in their primary form as ores is stunning in its simplicity, and must not have been understood by Thomas Townsend Brown.

Novel alloy compositions for manufacture of resonant metals with superhard characteristics offering supersharp surgical instruments were known to the Atlanteans, enabling bloodless surgeries where the severed flesh was instantly cauterized by an electrical charge transmitted through the instrument itself.



The technical work of Ax-Tell and Asphar in Egypt 30,000 years ago was replayed during the American industrial incarnations of the same entities –as Thomas Townsend Brown and Nikola Tesla– who developed the Tesla Gravity Motor with Edgar Cayce, otherwise known as "Tesla's black box motor"!

Another interesting detail mentioned by the Source concerns the necessity for 'blood to be changed' before each period of regeneration in the HHO plasma chambers within the pyramid. Exsanguination of the body before regeneration allows *the vibrations of the blood to be replaced more rapidly by new blood cells*, as conducted in the Temple of Sacrifice by an assistant of the Priest called a 'bleeder':

Asta-olaxen (3478-2): Before that the entity was in the Egyptian land when there were those activities which had to do with the Temple of Sacrifice. Then the entity was what today would be called a bleeder, or one who operated with certain activities for the removal of appendages for some of the beings or individuals of that period. The name then was Asta-Olaxen.

Among the second generation of Atlanteans born in the temples of Egypt was Ajax-Totertenm, apparently named after the elder Atlantean leader Ajax, who also served in the Temple of Sacrifice where electro-surgical removal of unwanted animal 'appendages', 'appurtenances' was conducted:

Ajax-totertenm (Reading 2927-1): Before that the entity was in the Egyptian land, during those periods of what is termed the reconstruction, or the development of individuals to particular or definite activities in the vocational forces.

There the entity was most active in the Temple of Sacrifice, with its establishments and the abilities for using those things which had been presented from the Atlanteans, where electrical forces –as termed in the present– were used as the means for removal of forms of appendages, or of those things that caused forms of reaction in the combination of the brain forces of body-influence, and the environmental forces as produced through those periods of unfoldment of knowledge and the use of same in the experience of individual lives. The entity then was in the name Ajax-Totertenm.

Spiritual and physical aspects of the cleansing activities introduced by the Atlantean scientists were given during a Life Reading for a client who had a previous incarnation as a priest in the Temple of Sacrifice during the Ra-Ta period, whose Paleo-Sanskrit devotional name 'Ai-Si' means "Aye, Yours":

Ai-si (Readings 275-11,43): In the one before this we find in that land now known as the Egyptian, and during that period [of Ra-Ta] when there was the height of the first understanding –in an expressive manner– of man's relationships to his Maker and man's relationships to his fellow man. In that first school established as a curative and as a preventative, did the entity act in the capacity of an aide to those who ministered in this period. In the name Ai-Si.

The entity gained through this experience, and many were the combinations of delicacies as were given to those recuperating from fevers, from injuries external in battle, and those various conditions that dealt with the developments of the *inner* man...

In the Temple of Sacrifice... there is the falling away of those influences in which man had come by his projection of self into matter that there might be the satisfying of desires of flesh as in animal associations and matter relating one to another; which feeding upon itself, as flesh upon flesh, bringeth corruption in the very souls of men. So was there the breathing upon the bodies that there might be the crucifying of the activities in the desires of body, the desires of flesh, the crucifying of those desires as in relation one to another. These must be blotted out as each soul offers itself in sacrifice that it may be put upon the altars or fires of love and *burned*, as it were, that there might be that purification in the flesh, that there might become again the dross burned away and the pure soul be one with that Creative Energy. Then, as there may be seen, the attuning of the music as may be in the day; the viola tuned to the vibrations of the fires of nature may be destructive or smothering or aflaming same.

So in that Temple of Sacrifice did thou minister there, in the purity of thy body, in the abilities of thy self to aid those that offered themselves in those manners of purifying; that burned away not only the desires of the flesh but the appendages of same that marred their bodies. And thus through much of thine effort came forth man as he walks upright today; no longer with the feet as of the cloven ox; or the horns as of the roe, the goat; nor the hog; nor those that would make themselves as a tree, nor those whose bodies were alive with the serpents of wisdom. But rather in the godly sons of the sons of God that wasted not their wanton selves in the

mire of despair with the sons of men but kept the faith; as thou –in thy purifying of same– made for those vibrations that in the music as of the spheres brought that purifying through attuning the vibrations with the destructive forces as manifested themselves in nature, as *tore away* in matter that which hindered the individual, the soul, from knowing and being at-one with that Creative Force as thou had gained and did manifest in that experience.



The exhaustive explanation offered by the Source through Edgar Cayce clearly identifies the genetic manipulation of individuals for the enslavement of their offspring as the primary purpose of the bizarre practices of the sons of Belial, involving fornication with animals of all kinds. While the great majority of such acts would not produce human/animal hybrid offspring in a natural setting, *highly advanced genetic manipulation techniques applied by Belial enabled the widespread infiltration of animal genetic sequences into the human genome.*

These surprising clarifications also coherently explain the modern-day prevalence of such unusual deformations of the human physique, the most common of which seems to be the retention of tails on newborn infants that are not normally present after the second trimester of development.

In modern-day India, individuals born with remnant tails are honored by many as possessing divine traits of the Monkey Deity Hanuman, yet such simian appendages represent the malignant genetic legacy of the Atlantean sons of Belial.

Humanity's growing awareness of the bizarre sexual exploitation and genetic manipulation of terrestrial human beings by extraterrestrials (that abduct their victims by levitation into HHO-plasma cloaked discoidal spacecraft) can be further understood as a continuation of the perverse sexual activities of Belial during the Atlantean experience. *Today, these activities are associated with reptilian humanoids.*

The congruence of past life information provided by Edgar Cayce in the 1930s and 40s with the surprising diversity and complexity of the human genome being discovered at the present time by geneticists of the Information Age once again confirms the stark accuracy of the Cayce material.

A Life Reading was also given by Cayce for a woman who was previously incarnated during the Ra-Ta period, as an individual afflicted with unwanted cloven or hoofed lower limbs who had voluntarily undergone surgical procedures and regeneration in HHO plasma chambers to regrow fully human legs while restoring genetic purity capable of producing fully human offspring:

She-pat-hel (Readings 585-2,12): Before that we find the entity was in the land now called Egypt, during the periods when there were the dispersing and the giving to others of those things that had become tenets in the activities of those that had followed the building up of what may be termed one of the greater civilizations or periods of approach of man to the Maker, and the ability to manifest same in the Earth. Little needs of labor physically, yet this of itself became a stumbling block.

The entity, though, then in the name She-pat-hel, gained in the experience; for the entity, while comprehending little of those things that were taught by the Atlanteans, gained much from those that were of the natives and those peoples that had come into the land from the Syrian and the Chaldean –as they were later called. For the entity was among those that *cleansed* themselves through the fires of the Temple Service, and made for the growths for those things in the teachings of those that went as emissaries to other lands; being associated then with the king in the ministry, the priest in the lessons, those in the temples as the friend and aid, the emissaries as one that counseled oft with them...

The entity was among those that, by its own volition, chose to pass through those periods of cleansing in the Temple of Sacrifice. Those appendages (for the entity was cleansed) were in the lower limbs, as would be indicated in the present; then those things that had to do with the characterization of feelings, innate prejudices, innate activities that brought and do bring about much of the dissensions in the present experience of this entity as well as many another.

In the period the entity was prepared especially for the charge as an emissary, or one that would enable those in those stages of evolution to develop or grow out of those experiences that had become entangled in matter. These were of the offspring of the mixtures of the children of the Law of One and those that had been entangled in matter, with those various defects in the bodies. These gradually grew to be defects, as might be said; in the characteristics. Gradually grown out by associations, as in the present, these become common.

But those groups or individuals where there were racial prejudices, racial colors, racial activities (giving off the radiation such as to become odiferous in certain characterizations, that become repulsive to something within individuals), these –as indicated in the entity's experience– were something to be conquered there. For, the entity was among those peoples that were the offspring of the native Egyptians and the "things" that had appendages. These, especially at that time were exhibited as feathers on the limbs of the native Egyptians, and then those peoples where there were the attempts for the purification not only of color but of character. These had been purified in the Temple through operative measures.

Then, to make application of same the entity found greater disturbances with the Atlantean peoples because of their color, because of their odor. These became very repulsive to the entity until –through those purifications in the Temple– there was the changing of those vibrations of the body forces through the electrical charges that were a part of the application that becomes a part of man's experience in the present.

The high vibrations, of course, are destructive, while the creative or the unfolding or the various grades from various characters of electrical changes are a part of the body forces. There, as may be experienced, when such are used in various forms, they may not only destroy disorders or diseases in a body but may also change entirely the attitude of an individual towards the entertaining of certain characteristics that are a part of the urges held to be at variance with certain characteristics in other individuals; unless these have passed through their normal development of associations.

These, then, were the activities of the entity through that experience; meeting those various influences, and then –after the purification– becoming active in the capacity as an emissary to other lands. The entity chose the Carpathian and those areas where there were the aversions to certain groups of individuals that had other characteristics as: The associations with the feet of the goat, with the hoofs of the horse, with those things that had been associated with such. Thus did the entity bring about those activities that made for correcting many of those actions and factors that dealt with the associations of the bestial forces and the material forces of the sons of the Creative Force or God.

The sophisticated spiritual and biological knowledge of the Atlantean scientists has not been fully grasped, despite the wealth of descriptive detail provided through the Cayce Life Readings. Despite utilizing the deformed human/animal *Things* for slave labor, the Atlantean spiritual desire to free the material servitude of human beings was clearly manifested by their electro-surgical removal of animal appendages and regeneration of limbs, reversing genetic defects inflicted on the worshippers of Belial.

Through Cayce, the Source also describes the multi-frequency resonance of standing waves as "music as of the spheres" –generated by three acoustic frequencies in Fibonacci ratio. Standing wave resonance was achieved in the temples by the geopolymer construction of corbelled ceilings such as the magnificent example known today as the Grand Gallery of the Great Pyramid (opposite), then known as the 'Temple Beautiful'. The regularly stepped walls generate standing waves between each set of faces, altogether creating a multi-frequency resonance for biorhythmic healing of the body.



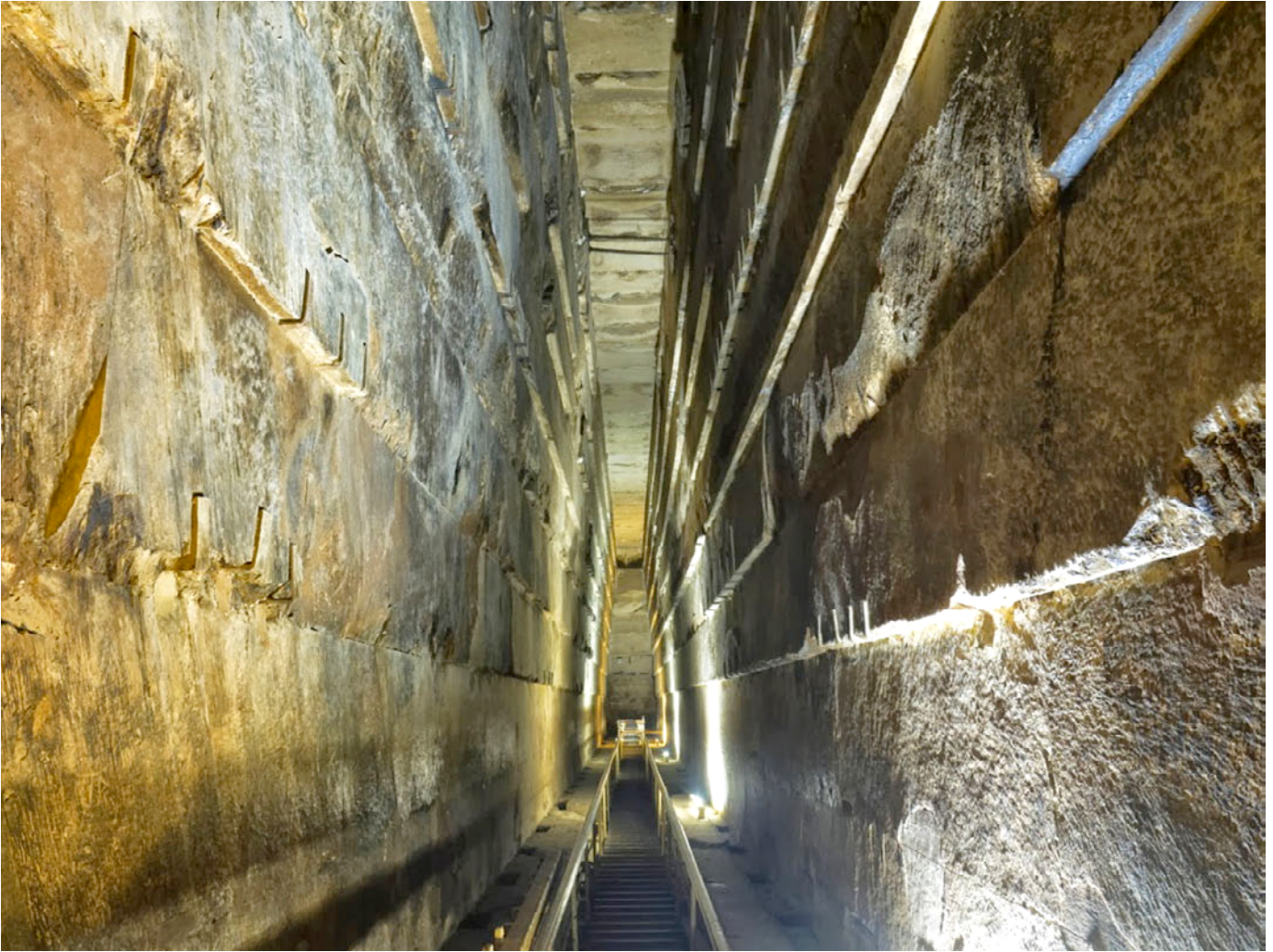

While sacrifice of animalistic desires and genetic influences was being conducted in the Temple of Sacrifice, parallel genetic cleansing activities undertaken by large groups in the Temple Beautiful were of a more advanced nature, involving genetic purification for the purpose of service to global society in the form most suited to the individual according to his or her specific preferences and mental aptitude:

Ex-der-enemus (Reading 2533-4): And then there were the teachings and education through the Temple Beautiful, which would be the same as represented in today's universal school or college or institution of [higher] learning.

This entity, then Ex-der-enemus, was one of those born in that environ, as such a development and an unfoldment began. And with the establishing of the homes, and the environs or surroundings of same, there came about those periods when there were losses by the natural sources, or nature, –fire, lightning, floods and the like, as well as death– that hindered, or caused the needs for the State to become responsible for the activities of the individual groups who became dependent upon such sources or natures...

Thus we find that the entity in its education was brought up in the school, as would be termed, in the Temple Beautiful; and along with the first ideas of vocational guidance or teachings that were a part of this institutional work, by the various groups that were designated through their choice or their abilities or their selection because of abilities. There we find that the entity presented the first idea as to how there might be assurances to individual families as to how their own affairs, their own homes, their own farms, their own places of business, their own choice of the selective work, might be carried on, by groups contributing to a general fund that was handled by the individual entity; and there was the license given to each group –with certain numbers to be applied to each group, and each contributing so much to the welfare. Thus the whole sum was given to those to whom such assurance was given for protection; as to life expectancy and as to incidents or accidents or things that caused losses to such individual groups.

To be sure, in the beginning there was little of that we term today as life insurance, or assurance. For, the life expectancy in those periods extended over a hundred, and hundreds of years; and thus these were not accounted for, but rather there were those groups that chose to lay aside the outer shell when the life expectancy –as would be termed in the present– was completed, as it had been laid out by those who gave the assignment, or the activity as was chosen by the individual...

Thus the activity of the entity, –then known as Ex-der-enemus, –was in organizing or preparing, or making for this correlating of the ideas and ideals that brought about such a form of activity among the peoples of Egypt; this, of course, coming in that period quite a time –some seventy or seventy-seven (77) years– after the return of the Priest to the authority or power, but during the period when still the Priest Ra-Ta and Araaraart were considered the young rulers; though they, to be sure, were upward in years, –as was Ax-Tell... [also known as] Ajax who had been in authority in the Atlantean lands, –and gave a part of their activities.

Thus these formed what might be called today the board, or governing board, or suggestive board, to those various groups or unions, –that carried not only the means or manners of preparing individuals who maintained or retained activity in this individual form of service in whatever field had been chosen, but selected them to become active individuals –from those who showed their aptness in certain forms of service; as in the diplomatic service, or in the exchange with other nations or states or groups with which there was being formed some character of relationship.

The entity through the experience acted in those capacities indicated; keeping active through that period for some hundred and seventy-seven (177) years.

The extreme duration of 177 years given for the active service of Ex-der-enemus in the Orion pyramids reflects same extended lifespans of ~200 years that had also been given for other adherents to the resonant tenets of temple life during the extended period of Atlantean devotion to *the Law of One*. The parents of each individual prepared for temple service were themselves purified by prolonged regeneration periods in the HHO plasma chambers of the pyramids, *where conception also occurred*.

Psychoacoustic waterbirthing practices were previously developed by Atlantean ancestors long before the Second Destruction of the continent of Atlantis, described by Cayce as the Biblical Great Flood event that submerged the vast majority of Earth's landmasses approximately 30,000 years ago. The primary function of the Great Pyramid concerned the biorhythmic entrainment of mother and fetus to share the same regulated brainwave patterns at the 1.45Hz rest frequency of the human heartbeat.

Biorhythmic waterbirthing techniques undertaken in the King's Chamber of the Great Pyramid involved ingestion of gold and silver nanoparticles that *electroluminesce in infrared, red and blue wavelengths*. Known as celestial waters, or Soma in the Vedic hymns passed down to our times, these sacred purification techniques fostered lifespans exceeding 200 years during the Atlantean occupation period.

The original design of the Queen's chamber, as called today, included a recessed bath (also for waterbirthing practices) that is now hidden –*filled with stone blocks by the Egyptian government*. In each chamber, the baths were filled with rejuvenating colloidal waters, composed of the light form of hydrogen, called protium (ie. 0% deuterium water, or D<sub>2</sub>O), containing silver and gold nanoparticles.

*The special composition of Soma electrum water induces HHO plasma formation*, as directly recorded in hieroglyphic texts inscribed on the interior walls of the dynastic Egyptian pyramids of Saqqara:

House bright and dark of Heaven and Earth, for the [solar] ships put together; Great Pyramid, House of the gods with pointed peak; for Heaven-to-Earth it is greatly equipped. House whose interior glows with a reddish Light of Heaven, pulsating a beam which reaches far and wide; its awesomeness touches the flesh... House of Eternity: its foundations are stones, the water; its great circumference is set in the clay. House the rightness of whose howling the Great-Ones-Who-See-and-Orbit bring down to rest... Mountain by which Utu ascends... whose deep insides men cannot penetrate.

When under the special bioelectrification conditions within the pyramids' interior chambers, the electroluminescent gold and silver nanoparticles release infrared, red and blue light within the body's cells, thereby stimulating cellular regeneration throughout the human body. *By this advanced Vedic method, whole limbs were regrown over a period of six-and-a-half years in the Temple of Sacrifice.*





The red granite blocks of the interior chambers of the Temple Beautiful are colored by piezoelectric rose quartz crystals that convert all received acoustic waves into internal electrical fields, thereby acting as highly efficient walls for the resonating chambers of the pyramid. Resonant frequencies generated in the Grand Gallery induced the formation of standing waves in the upper chambers (above).

Each of the special rooms situated in the upper section of the Temple Beautiful was cast as resonant waterbirthing chambers, with sealable baths that have been erroneously referred to as 'lidded sarcophagi'. These were filled with lightwater (pure protium water) and sealed for use as an HHO plasma chamber. The lightwater would form a thick vapor in the sealed chamber, before forming HHO plasma at high resonance, producing healing wavelengths of infrared and ultraviolet light (UV-A).

Regeneration periods were given for political ambassadors of other lands who had gathered at the Temple Beautiful for receiving a full genetic and cellular regeneration, reverting an elderly individual to a youthful state of health and renewed longevity, for the purpose of demonstrating the advanced biogenetic technology of the Atlantean temple practices as an invitation to those of various regions:

Emp-ulsheth (Reading 818-1): Before that we find the entity was in that known as the Egyptian land, during those periods when there were the disseminations of those tenets, those truths that had been as an accumulation of the Atlanteans, of the Mongolians, the Abyssinians, the people of Mu and of Og, and of the Poseidon, that the Priest gave through those ministrations of the regeneration of life –as it may be manifested in matter– to the emissaries that would go into the various lands for the distribution [of the high scientific knowledge of HHO plasma regeneration given by the Atlanteans].

The entity then was among the natives that were purified first in the temple, then in the sacrifice, then in the Temple Beautiful were the activities that made for the cleansing of many. And thus did the entity go among those of the varied lands as to *strengthen* the hands of those that had begun the work of establishing the teachings of that land. In the name Emp-Ulsheth, the entity gained through the greater portion of the experience.





Advanced geopolymer chemistry knowledge possessed by the Atlantean builders of the Ra-Ta period enabled the artificial reconstitution of natural stone varieties, such as limestones, basalts or granites. However, the purpose of the reconstitution process involved the enhancement of natural mineral combinations found in mined rock, *requiring the addition of finely ground ferromagnetic and pyromagnetic metals for generating the properties of a composite semiconductor.*

The red granite box located in the upper chamber of the Temple Beautiful (now called the Great Pyramid) was not a carved sarcophagus, but a resonator bath for waterbirthing that was cast from a geopolymer stone slurry comprised of disaggregated quartz from the Aswan quarries. Granite gravel was easily transported in sacks from Aswan to Giza for mixing and pouring *in situ*. The synthetic granite-based geopolymer formulation employed a *sodium/potassium poly(sialate)* binding matrix.





The same geopolymer stone fabrication processes employed by the Etruscan civilization were later inherited by the Romans, whose many magnificent geopolymer cement structures built ~1,800 years ago have endured to this day. Etruscan use of special low-temperature firing techniques apply alkali chemistry knowledge developed over 35,000 years ago, exactly as rediscovered in modern times by French chemist Dr. J. Davidovits –as Low-Temperature Geopolymeric Setting (LTGS).

Among the most ancient images of child-birth is an Etruscan blackware artifact made by LTGS (above) that displays the act of birth in a special context that has not been properly identified by archeologists. The clear image of mother and child –just prior to the moment of separation at birth– is depicted within a rectangular enclosure that represents a stone waterbirthing bath of the same type found in the upper chamber of the Great Pyramid (opposite). *The presence of water in the bath is shown by diagonal lines.*





The interwoven lifetimes of the core Atlantean soul group were clairvoyantly identified over the course of hundreds of psychic readings, revealing the hidden subconscious bathymetry of deeply held past life memories. The meandering incarnation streams of the central soul group have been assembled into a partial flow chart, summarizing *the geographical and temporal transfigurations of entities through time* (opposite).

In compiling the wealth of detailed past life information provided through the Cayce Life Readings for the Sons of the Law of One, several noticeable group dynamics become apparent. The most obvious of these is the tendency for souls to reincarnate together in specific time periods, while whole millennia past through various other phases of civilization on Earth when no incarnations occurred at all. Reincarnation periods selected by multiple members of the soul group include the Rama, Babylonian, Greek, Trojan, Palestinian and Roman civilizations, as well as more recent life convergences in France around Charles II and in the American frontier period. *Every soul in this group reassembled for the Atlantean psychoacoustic era and the American industrial era.*

The close companionship of Ajax and Aeoraen in Poseida and in the Great Pyramid 30,000 years ago has fully renewed itself in their present lives *through divine synchronicity and deep inner searching.*

Finding each other (in this life) in Ecuador in 2010, Alexander Putney and Suzanne Benoit (above) have combined their creative efforts toward the online publication of several ground-breaking science e-books through their extensive website ([www.Human-Resonance.org](http://www.Human-Resonance.org)). Recent literary collaborations include *Qi* (2012), *Infraworld* (2013), *Sanskrit* (2014), *Akasha* (2015) and *Magnetic Center* (2016). *Their recent discovery of the ancient Ohum pyramid complex of La Maná, Ecuador confirms past life memories.*

The name 'Alex' reflects the prior Atlantean name 'Ajax', while Suzanne's present surname 'Benoit' means 'blessed', which aptly describes her close-knit family and her two elder sisters, Michelle and Nicole. Her father Raoul J. Benoit passed in 2001 at the age of 69, whose past life as Araaraart has only recently come to light. Suzanne's present-day mother, Carolyn Connors-Howard, has appeared in various lives with Suzanne in the maternal role; in Egypt ~30,000bp, in India ~12,100bp, in America in the 1920s and again in this present lifetime during the digital era of the present Information Age.



## Reincarnation Sequences of the Sons of the Law of One

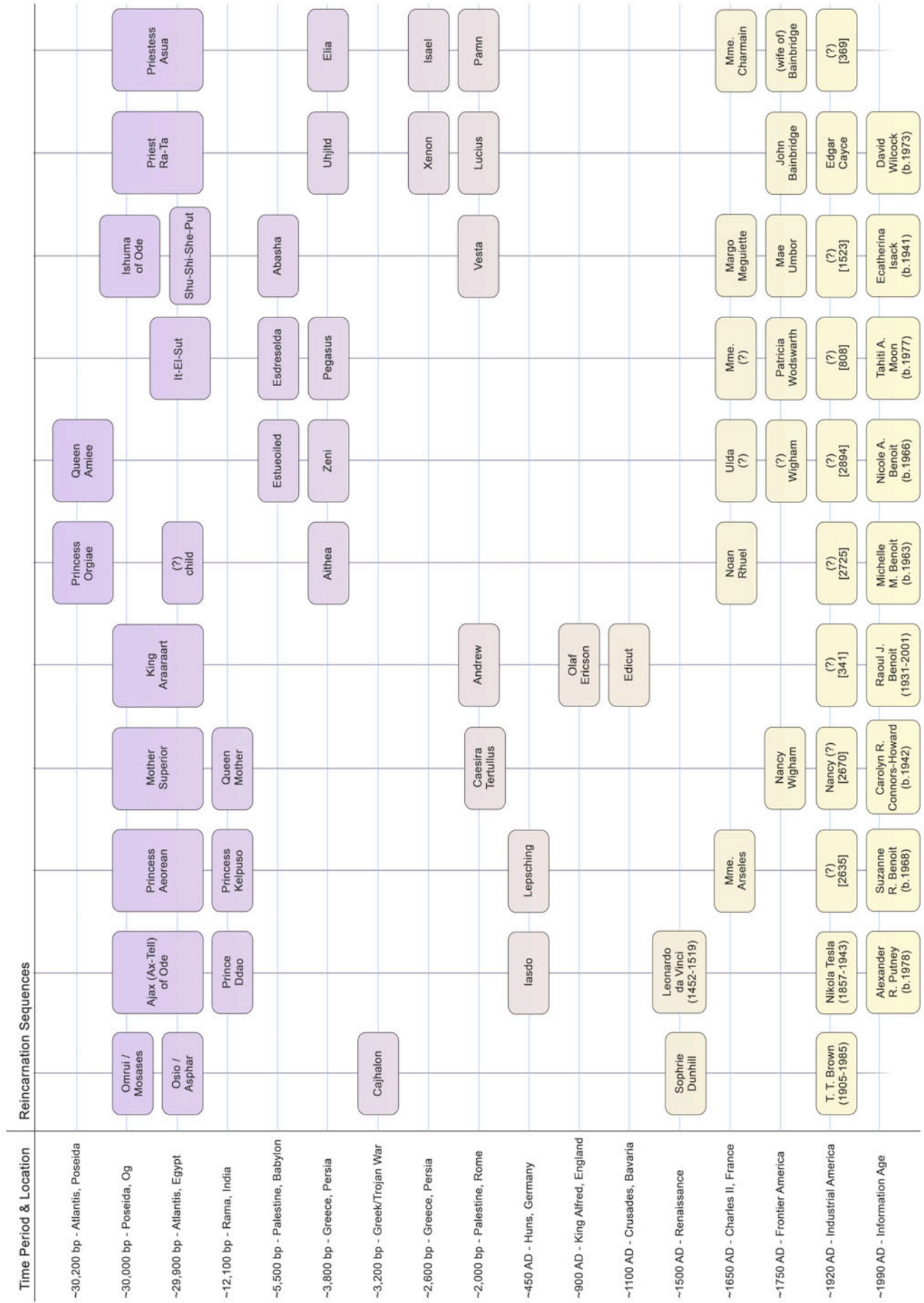

The great spiritual significance of the soul-borne urges that drive one's travels and searching in life, were discussed by the Source through Edgar Cayce on many occasions. The invention of Atlantean firestone by Ajax of Ode, and its technical application in the construction of Atlantean pyramids around the world from 29,900 years ago, has left its indelible mark on the souls of Alex and Suzanne, whose co-discovery of the Ohum capital city of On has unfolded through the subtle impetus of *psychic intuition*.

Insights on these strong, yet subconscious influences were given by the trance medium during psychic readings for Norfolk Study Group #1, pondering the nature and implications of soul memory and its relationship to archeological interest in the study of artificial geopolymer stone (Readings 364-1,3):

From time to time, in and through the information obtained for some individuals in their life readings, has come that they, as an entity or individual, occupied some particular place, or performed some activity in some portion of that continent; or emigrated from the continent to some other portion of the Earth's surface at the time, and began some particular development. These must have been a busy folk, for with their advent into other climes... they began to make many changes from the activities in that particular sphere in which they entered.

Then, if we are to accept such as being a fact or fiction, may truly depend upon what value to the human family knowledge concerning such a peoples would be in the affairs of individuals today. What contribution would information be to the minds of individuals, as to knowing or understanding the better or closer relations to the Creative Forces? Or, to put it another manner, what would information of that nature mean to my *soul* today?

Be it true that there *is* the fact of reincarnation, and that souls that once occupied such an environ are entering the Earth's sphere and inhabiting individuals in the present, is it any wonder that –if they made such alterations in the affairs of the Earth in their day, as to bring destruction upon themselves– if they are entering now, they might make many changes in the affairs of peoples and individuals in the present? Are they, then, *being* born into the world? If so, what *were* their environs –and what will those environs mean in a material world today?

...[W]hile the destruction of this continent [of Atlantis] and the peoples are far beyond any of that as has been kept as an absolute record, that record in the rocks still remains –as has that influence of those peoples in that life of those peoples to whom those that did escape during the periods of destruction make or influence the lives of those peoples to whom they came.

As they *may* in the present, either through the direct influence of being regenerated, or reincarnated into the Earth, or through that of the *mental* application on through the influences as may be had upon thought of individuals or groups by speaking from that environ.

These statements given by Cayce were entirely misunderstood by the study group for which they were given in 1932, yet find full clarification after so many decades of archeological investigation in many remote regions of the world. *Words of wisdom imparted by the Source make much more sense when one is aware that millions of tons of geopolymer firestone blocks lie unrecognized below the dirt of ages.*

By using the cryptic phrases "records in the rocks" the Source is subtly referencing "that [technological] influence" –*in the construction of Atlantean firestone pyramids*– shared in areas of Atlantean emigration from Poseida where firestone pyramids were built –the Yucatan Peninsula; the Andes mountains of Ecuador and Peru; the Pyrenees mountains, Spain; Giza and the Sahara region, Egypt; the Chaldean lands now submerged off the west coast of India; and the Gobi Desert of present-day Mongolia.

Many clear continuities appear in the past life sequence of Nikola Tesla, displaying the same advanced technical skill set and enabling the invention of mechanical devices for electrical healing, military defense and transportation in each incarnation experienced. In addition to firestone, Ax-Tell's advanced chemistry knowledge included advanced formulations for powdered explosives that could be safely handled, as related by Edgar Cayce in a Life Reading given for a male student on November 18, 1926:

Ececo (Reading 419-1): In the one before this we find in that known as the Atlantean period, when those first of the explosives were made. The entity then associated with that one Ax-Tell [now Nikola Tesla] that gave to the peoples the first combination of chemicals that gave explosives in a manner to be handled by peoples. The entity then in the name Ececo, and the entity gained in that period through the ability to take orders, and, as is seen in the present experience, that desire to know something of every mechanical device –yet all are easily forgotten or changed for another.



After exceeding 200 years of age as Ax-Tell, the entity later reincarnation in India ~12,100 years ago during the height of the Rama Empire. As the leader Ddao, he concerned himself with the formulation of chemical explosives during that period when regional conflicts escalated to belligerent attacks:

Ddao (Reading 487-4): In the one before this we find in the Indian rule, then the higher civilization in the Earth's plane. This we see 10,097 years ago before the Prince of Peace, and the entity then in the name of Ddao, and then the entity gave to that people the first show or combination of chemicals that produced explosives, as this we see was used against those tribes that attacked the ones this entity made head of.

During this lifetime, Ddao was the companion of Princess Kelpuso, the reincarnation of Aeoraen, who was raised to the position of directing the military activities of entire armies –and making use of advanced vimana spacecraft equipped with beam weapons and missiles containing the explosive charges, just as described in the Mahābhārata and Ramayana epic Sanskrit poems.

Kelpuso (Reading 2635-1): Before that the entity was in the Indian land, during those periods in which the peoples of the hill country and those of the valleys were antagonists.

The entity then was a princess in that land, and was raised to the position as one in authority to *command*, to demand of groups their activities, –yea, even of armies; and –as there were the periods of reclamation, of rebuilding– to put varied individuals whom the entity chose, by their deeds –not political but as of mercy and justice, that were the standards of the entity in that experience, in those places where there might be a regeneration for the peoples of the land... Then the entity was known as Princess Kelpuso.

Following their appearance together in India during the Rama period, Ddao and Kelpuso reincarnated anew in the personae of lasdo and Lepsching, leaders during the Hun Germanic expansion period:

lasdo (Reading 487-4): In the one before this, then, we find in that land now known as Germany when the first application of steam was given to move objects, and the entity then was from another country.

In this development as brought the entity on, we find in the name of lasdo, and the time was in that of [the Huns, 480 AD], and the personality as is in the present [life of Nikola Tesla] is the condition as given in the desire to keep things to self, or knowledge of conditions [–for resonant power generation using standing waves–] to self.

Lepsching (Reading 2635-1): Before that the entity was in the German land, during those periods when there were those activities in the attempt to make a united effort for greater expansion; during that known as the period of the Huns. The entity was in association with a leader [named lasdo], and through that experience brought fear and then hope into the lives of many.

Names then mean much. The tendency for this entity to know most everyone by more than one name is apparent. Hope as well as fear is the experience of the entity in this activity. Then name then was Lepsching...

*Q: Where have I been associated with Nikola Tesla in past experiences, what have been the relationships and what are the urges brought over into the present life?*

*A: If there will be the comparison of the experiences of each, it will be seen that there were the associations especially in the Egyptian land [and Indian land]–as husband and wife; in the German land as companions in good and in bad; and in the activities that were later a part of the experience of each, not given here –which they had both better forget!*

Scant details given by the Source for Lepsching and lasdo, as "companions in good and in bad", may relate to the fact that the Hun Germanic period was a violent one. During such dark times tribal leadership is often maintained through brutal means for instilling fear in rival groups. Perhaps this harsh reality explains the unusual comment from the Source, given through Cayce in trance, *that those lifetimes are better left unremembered*. The name 'lasdo' is Hebrew, a variant of 'Yahweh'.

After the Hun Germanic period incarnation, the spirit of Lepsching rejoined other soul group members from the Atlantean experience in another timeframe; during the exile of King Charles II of England to France (from 1651–1660) as Mme. Arseles. Companion souls that had been in the Atlantean period as Amiee, Ishuma, It-El-Sut and Asua also reincarnated for experiences in the court of King Charles in exile, as Ulda (?), Margo Meguiette, Mme. (?) and Mme. Charmain.

Following the lifetime of lasdo in the Germanic land dealing with steam-powered mechanical devices, the inventive spirit of lasdo reincarnated during the Renaissance period in Vinci, northern Italy. Born Leonardo di Ser Piero (1452–1519), the entity became the world-renowned artist, musician and inventor now called Leonardo da Vinci. *All data related to this past life originally given for Nikola Tesla was removed from the 487 series readings published in the Cayce Readings public archive.*

Incarnation continuity linking the work of Nikola Tesla and Leonardo da Vinci raises the deep spiritual question of soul-appreciation underlying their great creative wellspring –ever manifesting as artistic or inventive sensibility– that carries over so strongly from one lifetime to another (Reading 345-4):



Just as may be seen or reckoned with at this period in the present, that the activities of Leonardo da Vinci –in all his varied fields– are in 1933 more appreciated than they have ever been in the experience of any artistic field, or *any* field of art, in the whole period since his activity. Why?

Because the influence of the entity, or soul, is being expressed in a field of art and activity in the present experience [as Nikola Tesla in the creative field of invention]. Hence the very thought itself, of a soul, brings – with the abilities of the soul, an entity– a turning towards those very activities *of* the soul, or entity.

Here, the great social influence of the renowned inventor Nikola Tesla was being compared with his prior incarnation as Leonardo da Vinci, despite such connections having been largely omitted from the Cayce material. The great admiration held for the artist/inventor Leonardo da Vinci by those of his time has been well described (Vasari, G (2006) *'The Life of Leonardo da Vinci'* Kessinger Publishing):

In the normal course of events many men and women are born with various remarkable qualities and talents; but occasionally, in a way that transcends nature, a single person is marvelously endowed by heaven with beauty, grace and talent in such abundance that he leaves other men far behind... Everyone acknowledged that this was true of Leonardo da Vinci, an artist of outstanding physical beauty who displayed infinite grace in everything he did and who cultivated his genius so brilliantly that all problems he studied were solved with ease. He possessed great strength and dexterity; he was a man of regal spirit and tremendous breadth of mind...



Cayce also provided several past life readings for companions of da Vinci, including the modern-day reincarnations of Golden Humer, a commercial associate of Leonardo (Reading 1373-2); and Azul, an artist friend and co-laborer of Leonardo (Readings 1158-10, 2897-1,3). Another Life Reading was given for individuals with prior incarnations as assistants for the flight experiments of da Vinci (Readings 425-1, 490-1), one of whom was named Guiraleldio:

Guiraleldio (Reading 490-1): How, it may be asked, do you arrive at such conclusions from the entity's sojourn in those environs as indicated? By what the entity did in those environs with the abilities or knowledge that the entity had in its soul development during such a sojourn. From what, then, do you gather such information? Where are the records kept? Upon what are they recorded? Upon the etheric wave in time and space. What is the film that makes between time and space? That's what you are looking for, [490]! You'll find it!

This film –in this film is the difference between the movement of the atomic force about its center and the impression that is made *upon* those passing *between* light and heat, not darkness, for darkness may not exist where light has found its way. Though you may not be conscious or aware of its existence, its rays from the very records of time and space turn their emanations to give to a finite mind the dimensions themselves.

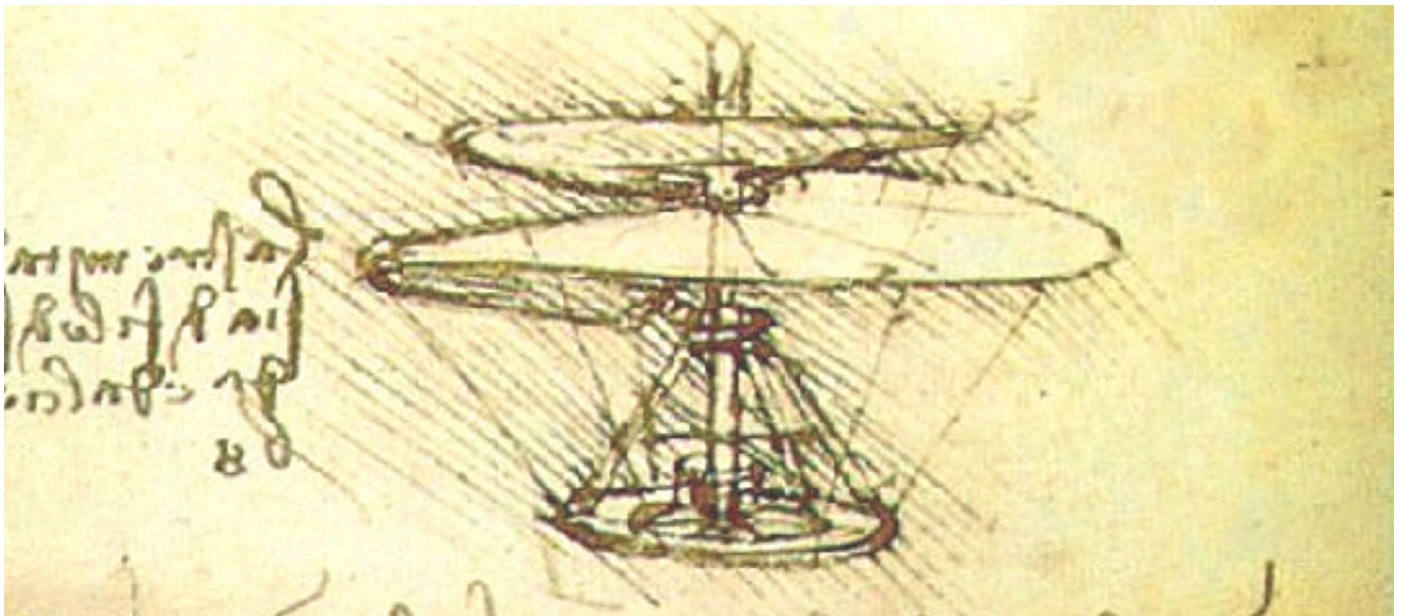

Before this we find the entity was in quite a different, yet quite a close character of development; for he was during those periods when the great artist, the great musician, the great scientist was attempting to make the first experiments with lighter than air machines, or painting the pictures that have become as the mystery of the smile of that particular one.

The entity then, in the name Guiraleldio, was that one who aided da Vinci when much experimentation was made, and much that has been accredited to the scientist da Vinci in the experimentations made may rather have been accredited to this entity during that sojourn...

Before this we find the entity was in that land now known as the Egyptian, during those periods when there were the sojournings from the Atlantean land.

The entity then was among the peoples that were of *one* in Atlantis, that journeyed to Egypt and aided in those establishments of the experimentations that dealt with the principles of plant *and* animal, rather than mineral, as to the applications of these principles to the curative forces in human ills; and may be said to have been upon the staff of the hospitalizations that were established during that building up in that period.

Through Cayce, the Source clearly related that *medical assistants of the Atlantean inventor Ax-Tell in the Temple of Sacrifice had reincarnated as assistants to inventor Leonardo da Vinci during the Renaissance period!* The complete list of past lives of Nikola Tesla originally given by Cayce included Leonardo da Vinci, and the evidence for this fact has been officially sealed by the ARE 'archivists', who *continue their denial of all public requests to view the original Edgar Cayce readings given for Tesla.*



Another mystery friend of Nikola Tesla has reincarnated as a close friend of Alex Putney. Born with the given name Tahiti August Moon, referencing her birth on August 20, 1977, her name and birthday have found new significance in the timing of dramatic astronomical events –*as Earth, the Sun and the entire solar system are set to undergo Magnetic Reversal in the weeks after the full moon of August 18, 2016.*

In her previous life Tahiti was a New York City housewife with a reputation for psychic abilities, designated as Mrs. [808]. Nikola Tesla and Mrs. [808] were photographed together at a fair in the early 1920s (above), during the same period their psychic Life Readings were being given by Edgar Cayce.

As It-el-sut, she had benefitted from the enhanced electromagnetic environment of the Great Pyramid at high resonance, receiving an extended lifespan of 190 years, during which time she organized the development of healthy domestic life of children raised through special Atlantean temple practices.

Auspicious signs and deeply held spiritual attitudes have also revealed the present-day reincarnation of Ishuma of Ode as Ecathernia Isack, a Romanian/American nurse reborn in Transylvania and living in Berkeley, California –and a devotee in the temples of several Indian teachers in this life.

As Edgar Cayce stated on many occasions, the Atlantean soul group has gathered together on the Earth's plane to be present for when "*the new dispensation is to come*" –the Magnetic Reversal of the solar system and the rebirth of the binary solar companion as a Red Dwarf star (Reading 3976-15):



[The beginning of a new age of spiritual awakening will be seen in...] the hearts and minds of those that have set themselves in that position that they become a channel through which spiritual, mental and material things become one in the purpose and desires of that physical body!

As to the material changes that are to be as an omen, as a sign to those that this is shortly to come to pass –as has been given of old, the sun will be darkened and the Earth shall be broken up in divers places –and *then shall be proclaimed*– through the spiritual interception in the hearts and minds and souls of those that have sought His way –**that His star has appeared, and will point the way for those that enter into the holy of holies in themselves...**



As to the changes physical again: The Earth will be broken up in the western portion of America. The greater portion of Japan must go into the sea. The upper portion of Europe will be changed as in the twinkling of an eye. Land will appear off the east coast of America. There will be the upheavals in the Arctic and in the Antarctic that will make for the eruption of volcanoes in the Torrid areas, and there will be shifting then of the poles –so that where there has been those of a frigid or the semi-tropical will become the more tropical, and moss and fern will grow.

And these will begin in those periods in 1958 to 1998, when these will be proclaimed as the periods when **His light will be seen again in the clouds**. As to times, as to seasons, as to places, *alone* is it given to those who have named the name –and who bear the mark of those of His calling and His election in their bodies. To them it shall be given.

As to those things that deal with the mental of the Earth, these shall call upon the mountains to cover many. As ye have seen those in lowly places raised to those of power in the political, in the machinery of nations' activities, so shall ye see those in high places reduced and calling on the waters of darkness to cover them.

And those that in the inmost recesses of themselves awaken to the spiritual truths that are to be given, and those places that have acted in the capacity of teachers among men, the rottenness of those that have ministered in places will be brought to light, and turmoils and strifes shall enter. And, as there is the wavering of those that would enter as emissaries, as teachers, from the throne of life, the throne of light, the throne of immortality, and wage war in the air with those of darkness, then know ye the Armageddon is at hand.

For with the great numbers of the gathering of the hosts of those that have hindered and would make for man and his weaknesses stumblingblocks, they shall wage war with the spirits of light that come into the earth for this awakening; that have been and are being called by those of the sons of men into the service of the living God. For He, as ye have been told, is not the God of the dead, not the God of those that have forsaken Him, but those that love His coming, that love His associations among men --the God of the *living*, the God of Life! For, He *is* Life...